



Post Office Box 3005
2831 Talleyrand Avenue
Jacksonville, Florida 32206-0005
www.jaxport.com

September 21, 2023

ADDENDUM NO. 01
TO
SPECIFICATIONS AND CONTRACT DOCUMENTS
FOR
INVITATION TO BID
BREASTING DOLPHINS – BERTH 22
DOLPHIN ADDITIONS (RE-BID)
JPA CONTRACT NO. C-1790R

The item(s) of this Addendum shall modify and become a part of the contractual documents for this project as of this date.
(Failure to acknowledge this addendum will be grounds for rejection of proposal.)

ATTACHMENTS TO CONTRACT SPECIFICATIONS

Attachment No. 01

Pre-Bid Meeting Minutes held on Tuesday, September 12, 2023 at 10:00 AM

Attachment No. 01a

Optional Site Visit Attendance held on Tuesday, September 12, 2023 at 2:00 PM

Attachment No. 02

Response to Questions

Attachment No. 03

2011.02.16 – Permit No. 16-297486-002-ES (2011-2016)

Attachment No. 04

Buck Island Cell B Toe Dike and Material Removal Plans for C-1737 Upland DMMA

Attachment No. 05

Appendix C – Dept of the Army Permit (Amended)

Acknowledgment of the following addenda is hereby made:

Addendum #1, Dated: _____ Initials _____

Company _____

NOTE: THIS ADDENDUM SHALL BE ACKNOWLEDGED IN YOUR BID SUBMISSION, FAILURE TO ACKNOWLEDGE ADDENDUM WILL BE GROUNDS FOR REJECTION OF BID.

PLEASE VISIT <http://www.jaxport.com/procurement/active-solicitations> OR CALL THE PROCUREMENT DEPARTMENT AT (904) 357-3017, PRIOR TO THE BID OPENING TO DETERMINE IF ANY ADDENDA HAVE BEEN RELEASED ON THIS CONTRACT.

PRE-BID MEETING MINUTES
JPA Contract: ITB C-1790R
BREASTING DOLPHINS - BERTH 22 DOLPHIN ADDITIONS (RE-BID)

Date: Tuesday, September 12, 2023

Time: 10:00 AM

Good morning! It is now 10:00 AM on Tuesday, September 12, 2023 and the Pre-Bid Meeting for JPA Contract No. ITB C-1790R BREASTING DOLPHINS - BERTH 22 DOLPHIN ADDITIONS (RE-BID) will now begin. Therefore, this meeting is being held via "ZOOM Meeting" teleconference which allows interested persons to view and participate remotely."

Please type your name and the company you represent in the "Chat Box".

This meeting is subject to Florida Sunshine Laws and therefore, is being recorded.

We will begin the meeting by introducing JAXPORT Staff Members:

JAXPORT STAFF IN ATTENDANCE:

Name: Sandra Platt	Title: Sr. Contract Specialist
Name: Brian Simmons	Title: Director, Procurement Services
Name: Retta Rogers	Title: Manager, Procurement Services
Name: Jose Vazquez	Title: Director, Project Management
Name: Michael Jones	Title: Director, Engineering & Construction Support
Name: Tripper Jones	Title: Project Manager
Name: Bobbi Mullins	Title: Coordinator, Construction Contracts
Name: Brian Williams	Title: Coordinator, SEB Programs
Name: Barry Nelson	Title: Manager, Planning

TAYLOR ENGINEERING STAFF IN ATTENDANCE:

Name: Jake Sydnor

IDENTIFY MEMBERS OF PUBLIC ATTENDEES

Please clearly state your name and the company you are representing. *(Allow time for each person to speak, add their name to the Attendance list, and ask again at the conclusion of the meeting for verification).*

COMPANIES' ATTENDANCE RECORD OF PRE-BID MEETING	
REPRESENTING AGENT	COMPANY'S NAME
1. Tim Pernsteiner	Michels Construction
2. Colston Lloyd	Russell Marine LLC
3. Sean Vandedrinck	Russell Marine LLC
4. Garrett Harrison	J. B. Coxwell
5. Katie Gearing	Superior Construction
6. Knox Clyburn	TIC
7. Chris Champigny	Michels Construction
8. Tony Landry/Matt Tate	Rush Marine
9. Keith Wicker	TIC
10. Cole Fairey	Michels

11. Shawn (iPhone) Stockwell	Michels Construction, Inc.
12. Carlos Araya	Mainstream Commercial Divers
13. Brandon Caudle	Dutra Dredge
14. Benjamin Huha	SJ Hamill Construction
15. Ben Hertford	Mainstream
16. Joe Lane	SJ Hamill Construction
17. Greg Bedenbaugh	Hal Jones
18. Jose Deliz	Hal Jones
19. Josh Adkinson	TIC
20. Lawrence Jappe	Michels Construction, Inc.
21. Steven K	Lumber Supply
22. Lee Underdown	JB Coxwell

Instructions for all participants/members of the public –

- i. To avoid any microphones transmitting sounds that causes feedback, echoes or sounds that will otherwise cause a disruption to this meeting, participants (regardless of how they are accessing this meeting) are asked to keep their microphones on “mute” at all times when *not* speaking. PLEASE TAKE A MOMENT AND “MUTE” YOUR MICs FOR THIS MEETING.
- ii. Any individual who wishes to speak, should “*unmute*” their microphones and wait to be recognized by the host before speaking.
- iii. When called upon, please announce your name and the company you are representing.
- iv. Each person speaking should do so clearly and slowly to ensure they are heard and understood for recording purposes and by other participants and attendees.

Key Dates:

- **Questions:** Any questions after the meeting must be e-mailed with the **SUBJECT: ITB_C-1790R** to my attention at sandra.platt@jaxport.com. Please do not send questions to anyone else. The deadline to submit questions by e-mail is: **Friday, September 15, 2023 at 12:00 PM (EST)** After that time no questions will be answered concerning this ITB.
- **Site Visit:** An Optional Site Visit will be held **Tuesday, September 12, 2023 at 2:00 PM**. Attendees will meet at Access Control, Blount Island Marine Terminal, 9620 Dave Rawls Blvd., Jacksonville, FL 32226. Contact Sandra Platt at (904) 357-3017 to have your names added to the list for transportation to the site. **HARD HATS, SAFETY BOOTS AND VESTS MUST BE WORN.**
- **Bids Due:** **Wednesday, October 4, 2023, at 2:00PM (EST)**. Invitation to Bids and all required supplemental material listed in the bid documents, must be submitted in **PDF Format Only** through E-Builder. Bids and supplemental documents submitted through Email or Fax will not be accepted or considered. **Until further notice, JAXPORT is *not* accepting any ITB packages submitted by Mail or Hand-Deliveries. Please visit JAXPORT’s website at www.jaxport.com for more information and updates.**

The PDF file name should read "C-1790R"

INVITATION TO BID DOCUMENTS

The Invitation to Bid document can be obtained from our website: <https://www.jaxport.com/procurement/active-solicitations/> If you should have any questions regarding the solicitation package, please submit them **by e-mail to Sandra Platt, Sr. Contract Specialist at: sandra.platt@jaxport.com or through E-Builder.**

- **Acknowledgment of Addenda** *(It is mandatory that the bidder acknowledge all addenda, the system will not allow you to submit your proposal until the addenda is acknowledged).*
- **Bidder Requirements:** Refer to **Page BCF-1** (list of documents required to be submitted with bid. It is mandatory that all required documents be uploaded in e-Builder when submitting your bids.)
- **Bid Form** – Total Bid Amount (Items 1-16), which includes all Lump Sum Work and Unit Priced Items
- **Time for Completion** – Refer to **Special Conditions, page SC-2 Item 1 243 calendar days after issuance of Construction NTP to successful bidder.**
- **Liquidated Damages** - \$2,650.00 per day, page SC-2, Item 2d.
- **This project is fully funded State of Florida and JAXPORT.**
- **SEB** Participation is encouraged (Brian Williams)
- **Scope of Services Overview** – Tripper Jones, Project Manager

SEB Requirements: Brian Williams, Coordinator, SEB Programs, addressed the requirements for the DBE requirements.

Scope of Services: Tripper Jones, Project Manager gave an overview of the Scope of Work as outlined in the specification documents.

Note: These minutes shall become a part of the solicitation documents and contract agreement. Any corrections, additions or errors will be brought to the attention of the Project Manager within 5 days after receipt of the minutes. It shall be the responsibility of the contractor submitting a proposal for this contract to ensure that all Subcontractors, Suppliers, and services that are incorporated into his proposal have received benefit of the minutes and any addenda that may be issued.

QUESTIONS: Questions were addressed during the meeting, however, bidders were advised to submit all questions in writing via email to Sandra.platt@jaxport.com. Response to all questions will be answered via Addendum and sent to all prospective bidders.

Thank you for your participation and we look forward to your bid submission.

Meeting adjourned at 10:29 AM.

Prepared By: *Sandra Platt, Sr. Contract Specialist (JAXPORT)*



Post Office Box 3005
 2831 Talleyrand Avenue
 Jacksonville, Florida 32206-0005

INVITATION TO BID

**BREASTING DOLPHINS - BERTH 22 DOLPHIN ADDITIONS
 (RE-BID)
 JPA CONTRACT NO. C-1790R**

RESPONSE TO QUESTIONS

- BUCK ISLAND DMMA** - At what location on Buck Island is the required discharge point? Will other Contractors be using Buck Island during this contract? What is the TSS limit for the discharge at Buck Island? What are the current elevations within the Buck Island DMMA? Please provide a drawings showing the detail for the Buck Island DMMA?

ANSWER: Discharge point will be Buck Island Cell B. Cell B is also used by JAXPORT’s dredging contractor to dispose of JAXPORT’s Berths dredged material. For reference and more information on discharge point, turbidity, etc., this addendum includes copies of the permit and drawings.

- DRAWING G-3 SURVEY** - The survey of the dredge area is over two years old. Has any maintenance dredging been performed since the survey show on the drawings? Is there a more current survey available? Please provide the XYZ survey data shown on the drawings?

ANSWER: The Contractor shall refer to the survey data shown in the Construction Drawings.

- TECH SPEC – APPENDIX D** - What is the datum for the surface elevation shown on the boring logs? Is the datum MLLW or NAVD88?

ANSWER: Per Geotechnical Engineering Report, Elevation Datum is Mean Low Low Water (MLLW).

- GEOTECH – BORING LOGS** - Please provide the northing and easting location of each boring.

ANSWER: Final coordinates at boring locations were not provided by the Geotechnical Engineer. See coordinates below for approximate locations as proposed prior to drilling:

BORING	EASTING	NORTHING	TYPE
B-1	482851.45	2204432.38	10 SPT
B-2	482993.62	2204990.56	10 SPT
B-3	483087.78	2205071.95	20 SPT
B-4	483075.5	2205213.42	20 SPT
B-5	483212.45	2205064.92	100 SPT
B-6	483044.14	2204825.99	100 SPT
B-7	483123.54	2204704.15	100 SPT

- Tech Spec FLDEP Permit - Turbidity Monitoring** - The permit indicates the location and frequency for

"Background" samples but does not for "Compliance" samples. At what location is the Compliance turbidity sample to be collected?

ANSWER: "Compliance" turbidity sample locations shall be determined by the Contractor.

6. **Tech Spec FLDEP permit - Turbidity Curtain** - Specific condition 10 states "Prior to the initiation of any work authorized by this permit, floating turbidity screens with weighted skirts shall be placed around the dredge area". The NOAA condition b for manatees states "Turbidity curtains and other in-water equipment shall be placed in a manner that does not entrap protected species within the project area and minimizes the extent and duration of their exclusion from the project area. The high berth traffic does not make a turbidity curtain feasible for dredging operations on this project. Due to the high berth traffic, will the Contractor be required to have turbidity curtains in the active berth area? Please define the exact area required for turbidity curtains if required?"

ANSWER: FDEP Permit No. 16-0010303-023-EI, as modified by Modification No. 16-0010303-024-EM, does not require the use of turbidity curtains, screens, or skirts. Please refer to Appendix B for the FDEP permit; specific condition 10 does not mention the use of turbidity curtains, screens, or skirts.

Appendix C, Department of the Army Permit SAJ-1994-03114 (SP-BJC) , references the old, un-modified FDEP permit. The reference to the old permit has been removed for clarity. See amended Appendix C. (**See Attachment No. 05**).

7. **S-14 Repair and Rehabilitation Plan** - The note on drawing S-14 shows the two new CSB-39 bollards that are replacing the existing bollards, the note states "Existing anchor bolts shall remain in place and be inspected by the engineer prior to installation of new bollards." In the process of removing the existing bollards, if the bolts are damaged, is core drilling the existing dolphin in order to remove the existing bolts acceptable?

ANSWER: For bidding purposes, the Contractor shall assume that the condition of the existing bollard anchor bolts are satisfactory for re-use. During the removal of existing bollards, the Contractor shall implement the appropriate means and methods to ensure preservation of the existing anchors.

8. **S-10 Fender Replacement Plan, Note 6** - Please provide a connection detail, including the anchor bolt pattern/diameter/depth for the cylindrical fenders that are to be reinstalled after the cone fenders have been installed?

ANSWER: To the greatest extent possible, the Contractor shall re-use existing fender support brackets for re-installation of existing cylindrical fenders. Per sheet S-10 note 4, the Contractor shall submit a work plan for the removal and installation of fenders prior to the commencement of work.

9. **Section 01 45 00 Page 3 of 7 Subsection 3.04 D of the Specs** - Will the port require a registered land surveyor for construction layout during the execution of the work? This would require the contractor to continuously employ a registered land surveyor throughout the lifetime of the project. This is generally not the case for these types of projects due to the large potential impacts to the contractor's bid price.

ANSWER: As required per Technical Specification section 01 45 00, paragraph 3.04.D.1, a licensed Professional Land Surveyor registered in the State of Florida shall perform all layouts of the work and quantity surveys required to carry out the project work.

10. **Section 01 45 00 Page 3 of 7 Subsection 3.04 D of the Specs** - Will the port require a registered land surveyor for as-built records?

ANSWER: Yes. As-built surveys shall be performed by a Professional Land Surveyor licensed in the state of Florida and experienced in topographic and bathymetric survey work. Please refer to Technical Specifications section 01 77 00 paragraph 1.02.B.

11. **Addendum #2, Question #22** - Due to the re-release of the project, please update the following expected dates previously given in addendum #2
- Contract Execution Date
 - NTP Date?

ANSWER: After Bid Opening, final approvals are expected to be received late October, contract execution is expected to occur mid-November, and NTP is expected to be issued mid-December after Bonds/Insurance requirement are clear (subject to changes).



Florida Department of Environmental Protection

Northeast District
7825 Baymeadows Way, Suite B200
Jacksonville, Florida 32256

Rick Scott
Governor

Jennifer Carroll
Lt. Governor

Herschel T. Vinyard Jr.
Secretary

SUBMERGED LANDS AND ENVIRONMENTAL RESOURCES PROGRAM

Permittee/Authorized Entity:

Jacksonville Port Authority
2831 Talleyrand Avenue
Jacksonville, Florida, 32206, Duval County

Buck Island DMMA Cells A&B

Environmental Resource Permit

State-owned Submerged Lands Authorization - Granted

U.S. Army Corps of Engineers Authorization – Separate Corps Authorization Required

Permit No.: 16-297486-002-ES

Permit Issuance Date: February 16, 2011

Permit Construction Phase Expiration Date: February 16, 2016



Florida Department of Environmental Protection

Northeast District
7825 Baymeadows Way, Suite B200
Jacksonville, Florida 32256

Rick Scott
Governor

Jennifer Carroll
Lt. Governor

Herschel T. Vinyard Jr.
Secretary

April 4, 2011

David Kaufman
Senior Director of Planning and Properties
Jacksonville Port Authority
2831 Talleyrand Avenue
Jacksonville, Florida 32206

DEP File No.: 16-297486-002-ES

Dear Mr. Stubbs:

The permit that was issued to the Jacksonville Port Authority on February 16, 2011 contained several items that you wanted modified. Please replace the entire document with the attached permit that contains all of the requested modifications.

If you have any questions, please contact Aaron Sarchet at 904-256-1654 if via his e-mail address at aaron.sarchet@dep.state.fl.us. When referring to your project please use the DEP File number listed above.

Sincerely,

James R. Maher, P.E.
Program Administrator
Environmental Resource Program

AMS/lgb

Attachment

Consolidated Environmental Resource Permit and Sovereignty Submerged Lands Authorization

Permittee: Jacksonville Port Authority

Permit No: 16-297486-002-ES

PROJECT LOCATION

The activities authorized by this Permit and sovereignty submerged lands authorization are located at 0 Ft. Caroline Road Jacksonville, Florida 32225, in Section 27, Township 1 South, Range 28 East in Duval County, at 30°23'21.89"/ -81°28'56.55".

AUTHORIZATIONS

Buck Island Dredge Material Management Area Cells A&B

Project Description

The permittee is authorized to conduct weir rehabilitation of Buck Island which includes the replacement of existing weir structures, the installation of the return water piping, dike rehabilitation above the mean high water level, and the installation of permanent pipe extensions and stabilization features at the toe of the dike below mean high water level within the St. Johns River, a Class III water, not an Outstanding Florida Waterbody, not an Aquatic Preserve. Authorized activities are depicted on the attached exhibits.

The project described above may be conducted only in accordance with the terms, conditions and attachments contained in this permit. The issuance of this permit does not infer, nor guarantee, nor imply that future permits or modifications will be granted by the Department.

Sovereignty Submerged Lands Authorization

The activity is located on submerged lands owned by the State of Florida. It therefore also requires authorization, from the Board of Trustees of the Internal Improvement Trust Fund (Board of Trustees), pursuant to Article X, Section 11 of the Florida Constitution, and Sections 253.002 Florida Statutes (F.S.).

As staff to the Board of Trustees of the Internal Improvement Trust Fund (Board of Trustees), the Department has determined that the activity qualifies for a Letter of Consent, as long as the work performed is located within the boundaries as described herein and is consistent with the terms and conditions herein.

Federal Authorization

A copy of this permit has been sent to the U.S. Army Corps of Engineers (USACE). The USACE may require a separate permit. Failure to obtain any required federal permits prior to construction could subject you to enforcement action by that agency.

Coastal Zone Management

This permit also constitutes a finding of consistency with Florida's Coastal Zone Management Program, as required by Section 307 of the Coastal Management Act.

Water Quality Certification

This permit constitutes certification of compliance with state water quality standards under Section 401 of the Clean Water Act, 33 U.S.C. 1341.

Permittee: Jacksonville Port Authority

Permit No: 16-297486-002-ES

Page 1 of 11

Permit Issuance: February 16, 2011

Permit Expiration: February 16, 2016

Other Authorizations

You are advised that authorizations or permits for this project may be required by other federal, state or local entities including but not limited to local governments and homeowner's associations. This permit does not relieve you from the requirements to obtain all other required permits or authorizations.

PERMIT /SOVEREIGNTY SUBMERGED LANDS CONDITIONS

The activities described herein must be conducted in accordance with:

The Specific Conditions

The General Conditions

The General Conditions for Sovereignty Submerged Lands Authorization

The limits, conditions and locations of work shown in the attached drawings

The term limits of this authorization

You are advised to read and understand these conditions and drawings prior to commencing the **authorized** activities, and to ensure the work is conducted in conformance with all the terms, conditions, and drawings. If you are utilizing a contractor, the contractor also should read and understand these conditions and drawings prior to commencing the authorized activities. Failure to comply with these conditions, including any mitigation requirements, shall constitute grounds for revocation of the Permit and appropriate enforcement action by the Department.

Operation of the facility is not authorized except when determined to be in conformance with all applicable rules and this permit/certification/authorization and sovereignty submerged lands authorization, as specifically described above.

SPECIFIC CONDITIONS

1. If prehistoric or historic artifacts, such as pottery or ceramics, stone tools or metal implements, dugout canoes, or any other physical remains that could be associated with Native American cultures, or early colonial or American settlement are encountered at any time within the project site area, the permittee shall cease all activities involving subsurface disturbance in the immediate vicinity of such discoveries. The permittee shall contact the Florida Department of State, Division of Historical Resources, Review and Compliance Section at (850) 245-6333 or (800) 847-7278, as well as the Department of Environmental Protection at 904-256-1700. Project activities should not resume without verbal and/or written authorization from the Division of Historical Resources. In the event that unmarked human remains are encountered during permitted activities, all work shall stop immediately and the proper authorities notified in accordance with Section 872.05, Florida Statutes. The following excerpt from **872.05 Unmarked Human Burials** is provided for informational purposes:

872.05(4) DISCOVERY OF AN UNMARKED HUMAN BURIAL OTHER THAN DURING AN ARCHAEOLOGICAL EXCAVATION.--When an unmarked human burial is discovered other than during an archaeological excavation authorized by the state or an educational institution, all activity that may disturb the unmarked human burial shall cease immediately, and the district medical examiner shall be notified. Such activity shall not resume unless specifically authorized by the district medical examiner or the State Archaeologist.

2. Prior to commencement of work authorized by this permit, the permittee shall provide written notification of the date of the commencement and proposed schedule of construction to the Department of Environmental Protection, Northeast District, Submerged Lands/Environmental Resources Program, 7825 Baymeadows Way, Suite B-200, Jacksonville, Florida 32256-7590.

3. All wetland areas or water bodies, which are outside the specific limits of construction authorized by this permit shall be protected from erosion, siltation, scouring, excess turbidity, or dewatering. Turbidity curtains, hay bales, and other such erosion/turbidity control devices shall be installed pursuant to Chapter 6 of The Florida Land Development Manual, A Guide to Sound Land and Water Management, prior to the commencement of dredging, filling, or construction activity. The devices shall remain functional at all times and shall be maintained on a regular basis. Turbidity and/or sedimentation resulting from any activities associated with the project shall not be allowed to enter waters of the State.

4. Floating turbidity curtains (FDOT Type II or equivalent) shall be used to surround all open water work areas and shall remain in place until such time as turbidity levels within these work areas have reduced sufficiently so as not to exceed the State water quality standards.
5. The work shall be done during periods of average or low water.
6. The project shall comply with applicable State Water Quality Standards, namely:
Surface Waters, Minimum Criteria, General Criteria - 62-302.500,
Class III Waters - Recreation, Propagation and Maintenance of a Healthy, Well-Balanced Population of Fish and Wildlife. - 62-302.400.
7. There shall be no stockpiling of tools, materials (i.e., lumber, pilings, riprap, sheet piles) within wetlands, along the shoreline within the littoral zone, or elsewhere within waters of the state unless specifically approved in this permit.
8. All cleared vegetation (including logging slash), scrap wood, trash, garbage, construction debris and other foreign debris or material shall be removed from the wetlands and placed in approved landfill or other authorized upland location within 14 days of completion of the work authorized in this permit.
9. The structure authorized by this permit shall not be placed on any property, other than that owned by the permittee, without the prior written approval of that property owner.
10. Outside the specific limits of construction authorized by this permit, any damage to the wetlands/shoreline/littoral zone as a result of the boardwalk/dock/pier/bulkhead construction shall be repaired by reestablishing the pre-construction elevations and replanting vegetation of the same species, size and density as that in the adjacent undisturbed wetland or littoral areas.
11. In accordance with Florida Administrative Code Rule 62-341.021(15), F.A.C. "riprap" shall consist of unconsolidated boulders, rocks or clean concrete rubble with no exposed reinforcing rods or similar protrusions.
12. The waterward end of the pipe extension shall be marked in accordance with USCG requirements.
13. Within one year of issuance of DEP permit # 16-297486-002-ES, Jacksonville Port Authority must have an executed sovereign submerged easement for the project area.
14. The permittee shall ensure that the contractor follows the attached Dredged Material Management Area Operation Plan for Buck Island DMMA Cells A&B.

SPECIFIC CONDITIONS – CONSTRUCTION ACTIVITIES

15. This permit for construction will expire five (5) years from the date of issuance. If the construction is not completed within the specified time period, and the permittee wishes to complete the construction, then pursuant to F.A.C. Rule 62-343.120, the permittee shall apply for an extension of the permit and in a manner described by the Department sixty (60) days prior to the expiration date of the permit.
16. For the dike repair, the soil shall be compacted and density tests shall be performed to ensure that the designed 95 % dry density is obtained. The compaction shall be conducted in accordance with the specifications as stated in section 7.1 of the submitted Operations Plan.
17. A qualified geotechnical technician should inspect and test all compacted surfaces to determine that the in place natural soils and fill soils are properly densified and proper documentation of the required minimum compaction criteria can be provided.

18. Compaction tests shall be performed every 300 ft of embankment length or every 500 yd³ of completed embankment fill. Further, the permittee shall ensure the compaction tests cover each 1.0 foot lift.
19. A qualified geotechnical technician shall inspect and test all compacted surfaces to determine that the in place natural soils are properly densified and proper documentation of the required minimum compaction criteria shall be provided.
20. As built elevations of the completed dikes shall be provided by a licensed surveyor. Once the dikes have been filled and compacted to their design elevations/grades, appropriate erosion control/maintenance shall be provided.
21. Throughout construction, quality control/quality assurance inspections need to be conducted by competent inspector (s), and such inspector (s) should be on site at all times during DMMA (Dredge Material Management Area) construction and especially during installation of spillways/outfalls/conduits. The permittee shall keep a QA/QC report documenting the results of these inspections, including description of and justification for all deviations or variances from the permitted design specification. The permittee shall submit the report, as part of the as-built certification (see general condition 1. (j)) to the Department prior to obtaining the authorization.

SPECIFIC CONDITIOINS – OPERATION CONDITIONS

22. Operation of the facility is not authorized except when determined to be in conformance with all applicable rules and with the general and specific conditions of this permit.
23. The facility shall be rehabilitated and operated consistent with the approved operation plan (attached as part of the permit). A copy of the approved operation plan shall be kept on site and made available upon request for inspection. The permittee may periodically revise the operation plan for the site as necessary to satisfy the requirements of this permit due to changes in equipment or procedures on site, with prior approval of the Department. Unless otherwise determined by the Department, the revision of the operation plan does not require permit modification.
24. The uses of drawdown pump(s) for decanting is prohibited when it will result in direct discharge of water from the dredge cell by bypassing the weir(s) and discharge pipe(s). However decanting of such water through direct discharge is allowed in emergency situations.
25. If the inspection indicates a critical condition (as described by section 7.2 of the operation plan) that requires remedial action, the operator shall immediately cease dredging operations until the DMMA is repaired to the satisfaction of the Jacksonville Port Authority or USACE's engineer.
26. The permittee shall provide for annual P.E. inspections of the DMMA to ensure that the DMMA is functioning as designed and permitted. The permittee shall submit the inspection reports to the Department within 30 days from the date of inspection certifying that the DMMA as designed. In addition, the permittee shall state in the report what operational maintenance has been performed on the DMMA. The inspection is not required if the site did not operate during the year, however the inspection report shall indicate that the site did not operate during the calendar year (January 1 – December 30) . If the site has not been operating for 2 years or more, the permittee shall provide for the P.E inspection and furnish the Department the inspection report prior to operation.
27. If the DMMA is not functioning as designed and permitted, operational maintenance shall be performed immediately to restore the system. If the operational maintenance measures are insufficient to enable the DMMA to meet the design standards, the permittee shall either replace the DMMA or construct an alternative design. In this connection, the permittee shall submit a permit modification application within sixty (60) days of the date the DMMA was determined to be design deficient.
28. The permittee shall immediately notify the Department by telephone whenever a serious problem occurs at this facility. Notification shall be made to the Northeast District Office Environmental Resource Program Compliance Manager at (904) 256-1700. Within 7 days of the telephone notification, the permittee shall submit to the Department a written report explaining the extent of the problem, its cause, and what action has been or will be taken to correct the problem.
29. The use of hydraulic booster pumps in the return water weir outfall pipeline is not authorized without permission from FDEP which may include a subsequent modification to the operational permit. Hydraulic sump/dewatering pumps discharging into the non-pressurized riser weir system are allowable and do not require a permit modification.

Permittee: Jacksonville Port Authority

Permit No: 16-297486-002-ES

Page 4 of 11

Permit Issuance: February 16, 2011

Permit Expiration: February 16, 2016

SPECIFIC CONDITIONS – MANATEE CONDITIONS

30. All personnel associated with the project shall be instructed about the presence of manatees and manatee speed zones, and the need to avoid collisions with, and injury to manatees. The permittee shall advise all construction personnel that there are civil and criminal penalties for harming, harassing, or killing manatees which are protected under the Marine Mammal Protection Act, the Endangered Species Act, and the Florida Manatee Sanctuary Act.

31. All vessels associated with the construction project shall operate at "Idle Speed/No Wake" at all times while in the immediate area and while in water where the draft of the vessel provides less than a four-foot clearance from the bottom. All vessels shall follow routes of deep water whenever possible.

32. Siltation or turbidity barriers shall be made of material in which manatees cannot become entangled, shall be properly secured, and shall be regularly monitored to avoid manatee entanglement or entrapment. Barriers shall not impede manatee movement.

33. All on-site project personnel are responsible for observing water-related activities for the presence of manatees. All in-water operations, including vessels, shall be shutdown if a manatee comes within 50 feet of the operation. Activities shall not resume until every manatee has moved beyond the 50-foot radius of the project operation, or until 30 minutes has elapsed wherein a manatee has not reappeared within 50 feet of the operation. Animals shall not be herded away or harassed into leaving.

34. Any collision with or injury to a manatee shall be reported immediately to the FWC Hotline at 1-888-404-FWCC. Collision and/or injury should also be reported to the U.S. Fish and Wildlife Service in Jacksonville (1-904-731-3336) for north Florida.

35. Temporary signs concerning manatees shall be posted prior to and during all in-water project activities. All signs are to be removed by the permittee upon completion of the project. Awareness signs that have already been approved for this use by the Florida Fish and Wildlife Conservation Commission (FWC) must be used. One sign measuring at least 3 ft. by 4 ft. which reads *Caution: Manatee Area* must be posted. A second sign measuring at least 8 1/2" by 11" explaining the requirements for "Idle Speed/No Wake" and the shutdown of in-water operations must be posted in a location prominently visible to all personnel engaged in water-related activities. Please see the Florida Fish and Wildlife Conservation Commission website for information on how to obtain appropriate signs: http://www.myfwc.com/docs/WildlifeHabitats/Manatee_EducationalSign.pdf

36. To reduce the risk of entrapment and drowning of manatees, either a flap gate or bars or grates no more than 8 inches apart shall be installed on all weir outfall pipes to restrict manatee access. If grating is installed, it shall be placed on the accessible end(s) during all phases of the construction process and as a final design element.

GENERAL CONDITIONS

- (1) The following general conditions shall be a part of all permits issued pursuant to this chapter and Chapter 40C-40 F.A.C., unless the conditions are inapplicable to the activity authorized by the permit.
 - (a) All activities shall be implemented as set forth in the plans, specifications and performance criteria as approved by this permit. Any deviation from the permitted activity and the conditions for undertaking that activity shall constitute a violation of this permit.
 - (b) This permit or a copy thereof, complete with all conditions, attachments, exhibits, and modifications, shall be kept at the work site of the permitted activity. The complete permit shall be available for review at the work site upon request by Department staff. The permittee shall require the contractor to review the complete permit prior to commencement of the activity authorized by this permit.
 - (c) Activities approved by this permit shall be conducted in a manner which does not cause violations of state water quality standards.

- (d) Prior to and during construction, the permittee shall implement and maintain all erosion and sediment control measures (best management practices) required to retain sediment on-site and to prevent violations of state water quality standards. All practices must be in accordance with the guidelines and specifications in Chapter 6 of the Florida Land Development Manual: A Guide to Sound Land and Water Management (Florida Department of Environmental Regulation 1988), which are incorporated by reference, unless a project specific erosion and sediment control plan is approved as part of the permit, in which case the practices must be in accordance with the plan. If site specific conditions require additional measures during any phase of construction or operation to prevent erosion or control sediment, beyond those specified in the erosion and sediment control plan, the permittee shall implement additional best management practices as necessary, in accordance with the specifications in Chapter 6 of the Florida Land Development Manual: A Guide to Sound Land and Water Management (Florida Department of Environmental Regulation 1988). The permittee shall correct any erosion or shoaling that causes adverse impacts to the water resources as soon as practicable.
- (e) Stabilization measures shall be initiated for erosion and sediment control on disturbed areas as soon as practicable in portions of the site where construction activities have temporarily or permanently ceased, but in no case more than 7 days after the construction activity in that portion of the site has temporarily or permanently ceased.
- (f) At least 48 hours prior to commencement of activity authorized by this permit, the permittee shall submit to the Department a fully executed "Construction Commencement Notice" Form 62-343.900(3) indicating the actual start date and the expected completion date.
- (g) When the duration of construction will exceed one year, the permittee shall submit construction status reports to the Department on an annual basis utilizing an Annual Status Report Form 62-343.900(4). These forms shall be submitted during June of each year.
- (h) For those systems which will be operated or maintained by an entity which will require an easement or deed restriction in order to provide that entity with the authority necessary to operate or maintain the system, such easement or deed restriction, together with any other final operation or maintenance documents as are required by subsections 7.1.1 through 7.1.4 of the Applicant's Handbook: Management and Storage of Surface Waters, must be submitted to the Department for approval. Documents meeting the requirements set forth in these subsections of the Applicant's Handbook will be approved. Deed restrictions, easements and other operation and maintenance documents which require recordation either with the Secretary of State or the Clerk of the Circuit Court must be so recorded prior to lot or unit sales within the project served by the system, or upon completion of construction of the system, whichever occurs first. For those systems which are proposed to be maintained by county or municipal entities, final operation and maintenance documents must be received by the Department when maintenance and operation of the system is accepted by the local governmental entity. Failure to submit the appropriate final documents referenced in this paragraph will result in the permittee remaining liable for carrying out maintenance and operation of the permitted system.
- (i) Each phase or independent portion of the permitted system must be completed in accordance with the permitted plans and permit conditions prior to the initiation of the permitted use of site infrastructure located within the area served by that portion or phase of the system. Each phase or independent portion of the system must be completed in accordance with the permitted plans and permit conditions prior to transfer of responsibility for operation and maintenance of that phase or portion of the system to a local government or other responsible entity.
- (j) Within 30 days after completion of construction of the permitted system, or independent portion of the system, the permittee shall submit a written statement of completion and certification by a registered professional engineer or other appropriate individual as authorized by law, utilizing As Built Certification Form 62-343.900(5) supplied with this permit. When the completed system differs substantially from the permitted plans, any substantial deviations shall be noted and explained and two copies of as-built drawings submitted to the Department. Submittal of the completed form shall serve to notify the Department that the system is ready for inspection. The statement of completion and certification shall be based on on-site observation of construction (conducted by the registered professional engineer, or other appropriate individual as authorized by law, or under his or her direct supervision) or review of as-built drawings for the purpose of determining if the work was completed in compliance with approved plans and specifications. As-built drawings shall be the permitted drawings revised to reflect any changes made during construction. Both the original and any revised specifications must be clearly shown. The plans must be clearly labeled as "as-built" or "record" drawing. All surveyed dimensions and elevations shall be certified by a registered surveyor. The following information, at a minimum, shall be verified on the "as-built" or "record" drawings:

1. Dimensions and elevations of all discharge structures including all weirs, slots, gates, pumps, pipes, and oil and grease skimmers;
 2. Locations, dimensions, and elevations of all filter, exfiltration, or underdrain systems including cleanouts, pipes, connections to control structures, and points of discharge to the receiving waters;
 3. Dimensions, elevations, contours, or cross-sections of all treatment storage areas sufficient to determine stage-storage relationships of the storage area and the permanent pool depth and volume below the control elevation for normally wet systems, when appropriate;
 4. Dimensions, elevations, contours, final grades, or cross-sections of the system to determine flow directions and conveyance of runoff to the treatment system;
 5. Dimensions, elevations, contours, final grades, or cross-sections of all conveyance systems utilized to convey off-site runoff around the system;
 6. Existing water elevation(s) and the date determined; and
 7. Elevation and location of benchmark(s) for the survey.
- (k) The operation phase of this permit shall not become effective until the permittee has complied with the requirements of the condition in paragraph (i) above, the Department determines the system to be in compliance with the permitted plans, and the entity approved by the Department in accordance with subsections 7.1.1 through 7.1.4 of the Applicant's Handbook: Management and Storage of Surface Waters, accepts responsibility for operation and maintenance of the system. The permit may not be transferred to such an approved operation and maintenance entity until the operation phase of the permit becomes effective. Following inspection and approval of the permitted system by the Department, the permittee shall request transfer of the permit to the responsible approved operation and maintenance entity, if different from the permittee. Until the permit is transferred pursuant to section 7.1 of the Applicant's Handbook: Management and Storage of Surface Waters, the permittee shall be liable for compliance with the terms of the permit.
- (l) Should any other regulatory agency require changes to the permitted system, the permittee shall provide written notification to the Department of the changes prior to implementation so that a determination can be made whether a permit modification is required.
- (m) This permit does not eliminate the necessity to obtain any required federal, state, local and special district authorizations prior to the start of any activity approved by this permit. This permit does not convey to the permittee or create in the permittee any property right, or any interest in real property, nor does it authorize any entrance upon or activities on property which is not owned or controlled by the permittee, or convey any rights or privileges other than those specified in the permit and Chapter 40C-4 or 40C-40, F.A.C.
- (n) The permittee shall hold and save the Department harmless from any and all damages, claims, or liabilities which may arise by reason of the activities authorized by the permit or any use of the permitted system.
- (o) Any delineation of the extent of a wetland or other surface water submitted as part of the permit application, including plans or other supporting documentation, shall not be considered specifically approved unless a specific condition of this permit or a formal determination under Rule 62-343.040, F.A.C., provides otherwise.
- (p) The permittee shall notify the Department in writing within 30 days of any sale, conveyance, or other transfer of ownership or control of the permitted system or the real property at which the permitted system is located. All transfers of ownership or transfers of a permit are subject to the requirements of Rule 62-343.130, F.A.C. The permittee transferring the permit shall remain liable for any corrective actions that may be required as a result of any permit violations prior to such sale, conveyance or other transfer.
- (q) Upon reasonable notice to the permittee, Department authorized staff with proper identification shall have permission to enter, inspect, sample and test the system to insure conformity with the plans and specifications approved by the permit.
- (r) If historical or archaeological artifacts are discovered at any time on the project site, the permittee shall immediately notify the Department.
- (s) The permittee shall immediately notify the Department in writing of any previously submitted information that is later discovered to be inaccurate.
- (2) In addition to those general conditions set forth in subsection (1), the Department shall impose on any permit granted under this chapter and Chapter 40C-40, F.A.C., such reasonable project-specific conditions as are necessary to assure that the permitted system will not be inconsistent with the overall objectives of the District or be harmful to the water resources of the District as set forth in District and Department rules. Upon receipt of the notice of intended Department action, any person whose substantial interests are affected shall have the right to request a hearing in accordance with Chapter 28-106 and Rule 62-110.106, F.A.C.

GENERAL CONDITIONS FOR SOVEREIGNTY SUBMERGED LANDS AUTHORIZATION

Any use of sovereignty submerged lands is subject to the following general conditions are binding upon the applicant and are enforceable under Chapter 253, F.S. and, as applicable, Chapter 258, F.S.:

1. Sovereignty submerged lands may be used only for the specified activity or use. Any unauthorized deviation from the specified activity or use and the conditions for undertaking that activity or use will constitute a violation. Violation of the authorization will result in suspension or revocation of the applicant's use of the sovereignty submerged lands unless cured to the satisfaction of the Board of Trustees.
2. Authorization under Rule 18-21.005, Florida Administrative Code (F.A.C.), conveys no title to sovereignty submerged lands or water column, nor does it constitute recognition or acknowledgment of any other person's title to such land or water.
3. Authorizations under Rule 18-21.005, F.A.C., may be modified, suspended or revoked in accordance with its terms or the remedies provided in Sections 253.04, F.S. and Chapter 18-14, F.A.C.
4. Structures or activities will be constructed and used to avoid or minimize adverse impacts to resources.
5. Construction, use, or operation of the structure or activity will not adversely affect any species which is endangered, threatened or of special concern, as listed in Rules 68A-27.003, 68A-27.004, and 68A-27.005, F.A.C.
6. Structures or activities will not unreasonably interfere with riparian rights. When a court of competent jurisdiction determines that riparian rights have been unlawfully affected, the structure or activity will be modified in accordance with the court's decision.
7. Structures or activities will not create a navigational hazard.
8. Structures will be maintained in a functional condition and will be repaired or removed if they become dilapidated to such an extent that they are no longer functional.
9. Structures or activities will be constructed, operated, and maintained solely for water dependent purposes.
10. The applicant agrees to indemnify, defend and hold harmless the Board of Trustees and the State of Florida from all claims, actions, lawsuits and demands in any form arising out of the authorization to use sovereignty submerged lands or the applicant's use and construction of structures on sovereignty submerged lands. This duty to indemnify and hold harmless will include any and all liabilities that are associated with the structure or activity including special assessments or taxes that are now or in the future assessed against the structure or activity during the period of the authorization.
11. Failure by the Board of Trustees to enforce any violation of a provision of the authorization or waiver by the Board of Trustees of any provision of the authorization will not invalidate the provision not enforced or waived, nor will the failure to enforce or a waiver prevent the Board of Trustees from enforcing the unenforced or waived provision in the event of a violation of that provision.
12. Applicant binds itself and its successors and assigns to abide by the provisions and conditions set forth in the authorization. If the applicant or its successors or assigns fails or refuses to comply with the provisions and conditions of the authorization, the authorization may be terminated by the Board of Trustees after written notice to the applicant or its successors or assigns. Upon receipt of such notice, the applicant or its successors or assigns will have thirty (30) days in which to correct the violations. Failure to correct the violations within this period will result in the automatic revocation of this authorization.
13. All costs incurred by the Board of Trustees in enforcing the terms and conditions of the authorization will be paid by the applicant. Any notice required by law will be made by certified mail at the address shown on page one of the authorization. The applicant will notify the Board of Trustees in writing of any change of address at least ten days before the change becomes effective.

14. This authorization does not allow any activity prohibited in a conservation easement or restrictive covenant that prohibits the activity.

NOTICE OF RIGHTS

This action is final and effective on the date filed with the Clerk of the Department unless a petition for an administrative hearing is timely filed under Sections 120.569 and 120.57, F.S., before the deadline for filing a petition. On the filing of a timely and sufficient petition, this action will not be final and effective until further order of the Department. Because the administrative hearing process is designed to formulate final agency action, the filing of a petition means that the Department's final action may be different from the position taken by it in this notice.

Petition for Administrative Hearing

A person whose substantial interests are affected by the Department's action may petition for an administrative proceeding (hearing) under Sections 120.569 and 120.57, F.S. Pursuant to Rule 28-106.201, F.A.C., a petition for an administrative hearing must contain the following information:

- (a) The name and address of each agency affected and each agency's file or identification number, if known;
- (b) The name, address, and telephone number of the petitioner; the name, address, and telephone number of the petitioner's representative, if any, which shall be the address for service purposes during the course of the proceeding; and an explanation of how the petitioner's substantial interests are or will be affected by the agency determination;
- (c) A statement of when and how the petitioner received notice of the agency decision;
- (d) A statement of all disputed issues of material fact. If there are none, the petition must so indicate;
- (e) A concise statement of the ultimate facts alleged, including the specific facts that the petitioner contends warrant reversal or modification of the agency's proposed action;
- (f) A statement of the specific rules or statutes that the petitioner contends require reversal or modification of the agency's proposed action, including an explanation of how the alleged facts relate to the specific rules or statutes; and
- (g) A statement of the relief sought by the petitioner, stating precisely the action that the petitioner wishes the agency to take with respect to the agency's proposed action.

The petition must be filed (received by the Clerk) in the Office of General Counsel of the Department at 3900 Commonwealth Boulevard, Mail Station 35, Tallahassee, Florida 32399-3000. Also, a copy of the petition shall be mailed to the applicant at the address indicated above at the time of filing.

Time Period for Filing a Petition

In accordance with Rule 62-110.106(3), F.A.C., petitions for an administrative hearing by the applicant must be filed within 14 days of receipt of this written notice. Petitions filed by any persons other than the applicant, and other than those entitled to written notice under Section 120.60(3), F.S. must be filed within 14 days of publication of the notice or within 14 days of receipt of the written notice, whichever occurs first. Under Section 120.60(3), F.S., however, any person who has asked the Department for notice of agency action may file a petition within 14 days of receipt of such notice, regardless of the date of publication. The failure to file a petition within the appropriate time period shall constitute a waiver of that person's right to request an administrative determination (hearing) under Sections 120.569 and 120.57, F.S., or to intervene in this proceeding and participate as a party to it. Any subsequent intervention (in a proceeding initiated by another party) will be only at the discretion of the presiding officer upon the filing of a motion in compliance with Rule 28-106.205, F.A.C.

Extension of Time

Under Rule 62-110.106(4), F.A.C., a person whose substantial interests are affected by the Department's action may also request an extension of time to file a petition for an administrative hearing. The Department may, for good cause shown, grant the request for an extension of time. Requests for extension of time must be filed with the Office of General Counsel of the Department at 3900 Commonwealth Boulevard, Mail Station 35, Tallahassee, Florida 32399-3000, before the applicable deadline for filing a petition for an administrative hearing. A timely request for extension of time shall toll the running of the time period for filing a petition until the request is acted upon.

Mediation

Mediation is not available in this proceeding.

Judicial Review

Any party to this action has the right to seek judicial review pursuant to Section 120.68, F.S., by filing a Notice of Appeal pursuant to Rules 9.110 and 9.190, Florida Rules of Appellate Procedure, with the Clerk of the Department in the Office of General Counsel, 3900 Commonwealth Boulevard, M.S. 35, Tallahassee, Florida 32399-3000; and by filing a copy of the Notice of Appeal accompanied by the applicable filing fees with the appropriate District Court of Appeal. The Notice of Appeal must be filed within 30 days from the date this action is filed with the Clerk of the Department.

Executed in Jacksonville, Florida.

STATE OF FLORIDA DEPARTMENT
OF ENVIRONMENTAL PROTECTION

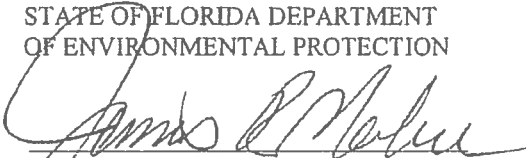

James R. Maher, P.E.
Program Administrator
Submerged Lands & Environmental
Resource Program

Attachments:

Exhibit 1, Project Drawings and Design Specs., 21 pages
Exhibit 2, Buck Island Operations Plan 9 pages
Commencement notice /62-343.900(3)
Annual status report/62-343.900(4)
As-built certification/62-343.900(5)
Inspection certification/62-343.900(6)
Transfer construction to operation phase/ 62-343.900(7)
Application for transfer of an ERP permit/62-343.900(8)

Copies furnished to:
U.S. Army Corps of Engineers
FWC, Imperiled Species Management Section
Consultant/Agent

CERTIFICATE OF SERVICE

The undersigned hereby certifies that this permit and authorization to use sovereignty submerged lands, including all copies, were mailed before the close of business on 4/4/11, to the above listed persons.

FILING AND ACKNOWLEDGMENT

FILED, on this date, under 120.52(7) of the Florida Statutes, with the designated Department Clerk, receipt of which is hereby acknowledged.

Randa Brattos
Clerk

4/4/11
Date

JACKSONVILLE HARBOR



PLANS
FOR REHABILITATION OF

DREDGED MATERIAL MANAGEMENT AREA BUCK ISLAND DUVAL COUNTY, FLORIDA



DEPARTMENT OF THE ARMY
JACKSONVILLE DISTRICT, CORPS OF ENGINEERS
JACKSONVILLE, FLORIDA

2011

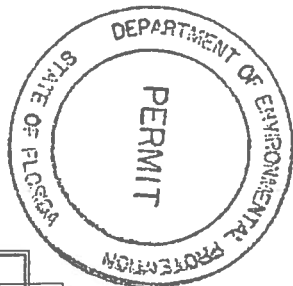

LOCATION MAP



INDEX TO DRAWINGS	
DWG NO	TITLE
GENERAL	
B-101	PROJECT VICINITY AND LOCATION MAP, LEGEND, INDEX TO DRAWINGS, ABBREVIATIONS AND GENERAL NOTES
B-102	CONTROL DATA
CIVIL	
C-101	EXISTING SITE PLAN
C-102	WEIR SITE PLAN
C-103	SHORELINE ENHANCEMENT PLAN AND TYPICAL SECTIONS
C-201	WEIR CROSS SECTIONS
C-202	PERIMETER AND CROSS ONE CROSS SECTIONS
C-203	ELONGATED AREA CROSS SECTIONS
STRUCTURAL	
S-101	CELL A AND CELL B STRUCTURAL PLAN
S-102	CELL A WEIR RISER SYSTEM PLAN
S-103	CELL B WEIR RISER SYSTEM PLAN
S-201	CELL A AND CELL B STRUCTURAL ELEVATIONS
S-202	TIMBER HULLWAY ELEVATIONS
S-203	WEIR RISER PANEL TYPICAL SECTIONS AND DETAILS
S-204	EMERGENCY GATE SECTIONS AND DETAILS
S-205	WEIR FOUNDATION AND RETAIN PIPE ANCHORAGE SECTIONS AND DETAILS
S-206	ALLIUM PLAN WITH COCK SECTIONS AND DETAILS
S-207	TIMBER HULLWAY AND END SUPPORT SECTIONS AND DETAILS
S-208	LADDER SECTIONS AND DETAILS

LEGEND:	
	CORE BORING
	TEST PIT
	MARKER BORING
	DITCHER TRENCHES SURVEY AND NUMBER
	FALLS OFF SHEET
	CENTERLINE DIKE
	EXISTING CONTOUR
	EDGE OF WATER
	EXISTING TOP OF DIKE
	CONTROL MONUMENT (HORIZONTAL AND VERTICAL)
	CONTROL MONUMENT (VERTICAL)
	UPLAND DISPOSAL AREA (DMA)
	ELEVATION AND LOCATION
	MARSH GRASS
	THICKET VEGETATION
	TIMBER POLE TYPE

ABBREVIATIONS	
APPROX.	APPROXIMATE
AZ.	AZIMUTH
CL	CENTERLINE
DN.	DIAMETER
DMMA	DESIGNED MATERIAL MANAGEMENT AREA
DWG.	DRAWING
EL.ELEV.	ELEVATION (FEET)
EW	EACH WAY
EP	EACH FACE
FOH	FOUNDATION
FR	FOUR FOOT RISE
FT	FEET
HDPE	HIGH DENSITY POLYETHYLENE
INVERT	INVERT
IRWG	IRREGULAR WIRE ROPE CORE
L	LENGTH OF CURVE
MSH	MESH
MLLW	MEAN LOWER LOW WATER
NDS	NATIONAL GEODETIC SURVEY
NAD83(83)	NORTH AMERICAN DATUM OF 1983, 1983 RE-ADJUST.
NAD83	NORTH AMERICAN VERTICAL DATUM OF 1988
N.T.S.	NOT TO SCALE
NEL #	NUMBER
POB	POINT OF BEGINNING
PC	POINT OF CURVE (BEGINNING POINT OF CURVE)
POE	POINT OF END
P.I.	POINT OF INTERSECTION
P.I.D.P.	POINT IDENTIFICATION
PT	POINT OF TANGENT (END POINT OF CURVE)
P.T.	PRESSURE TREATED
PT	POINT OF TANGENT INTERSECTION
PR	POLYMER PER SOLLAGE BUSH
R	RADIUS
SB	STAINLESS STEEL
STA.	STATION
T	TANGENT LENGTH
TDB	TOP OF DIKE BANK
TYP	TYPICAL
USCG	U.S. COAST GUARD
WVP	WELDED WIRE FABRIC
W	WITH



VICINITY MAP

GRAPHIC SCALE
NOT TO SCALE

- GENERAL NOTES:**
- ALL PLANNING FEATURES DEPICTED ON THESE PLANS ARE FOR INFORMATION ONLY AND WERE NOT PHYSICALLY LOCATED BY SURVEY MEASUREMENTS INDICATED. THE CONTRACTOR SHALL BE RESPONSIBLE FOR VERIFYING THE LOCATION OF ALL SUCH FEATURES THAT HIS DISTURBANCES ARE NECESSARY FOR OR AFFECT THE PERFORMANCE OF CONSTRUCTION OF THIS PROJECT.
 - SEE THIS DWG. FOR INDEX TO DRAWINGS, LEGEND, ABBREVIATIONS, LOCATION AND VICINITY MAPS.
 - SEE DWG. NO. B-102 FOR CONTROL DATA.
 - SEE DWG. NO. C-101 FOR TOPOGRAPHIC SURVEY NOTES
 - SEE DWG. NO. C-102 FOR WEIR SITE PLAN.

US Army Corps
of Engineers
Atlantic District

NO.	DATE	REVISION

DESIGNED BY	CHECKED BY	DATE

DEPARTMENT OF THE ARMY
CORPS OF ENGINEERS
ATLANTIC DISTRICT
JACKSONVILLE, FLORIDA

PROJECT VICINITY & LOCATION MAP, LEGEND, INDEX TO DRAWINGS, ABBREVIATIONS AND GENERAL NOTES

PROJECT VICINITY & LOCATION MAP, LEGEND, INDEX TO DRAWINGS, ABBREVIATIONS AND GENERAL NOTES

DATE: 10/1/83

G-101

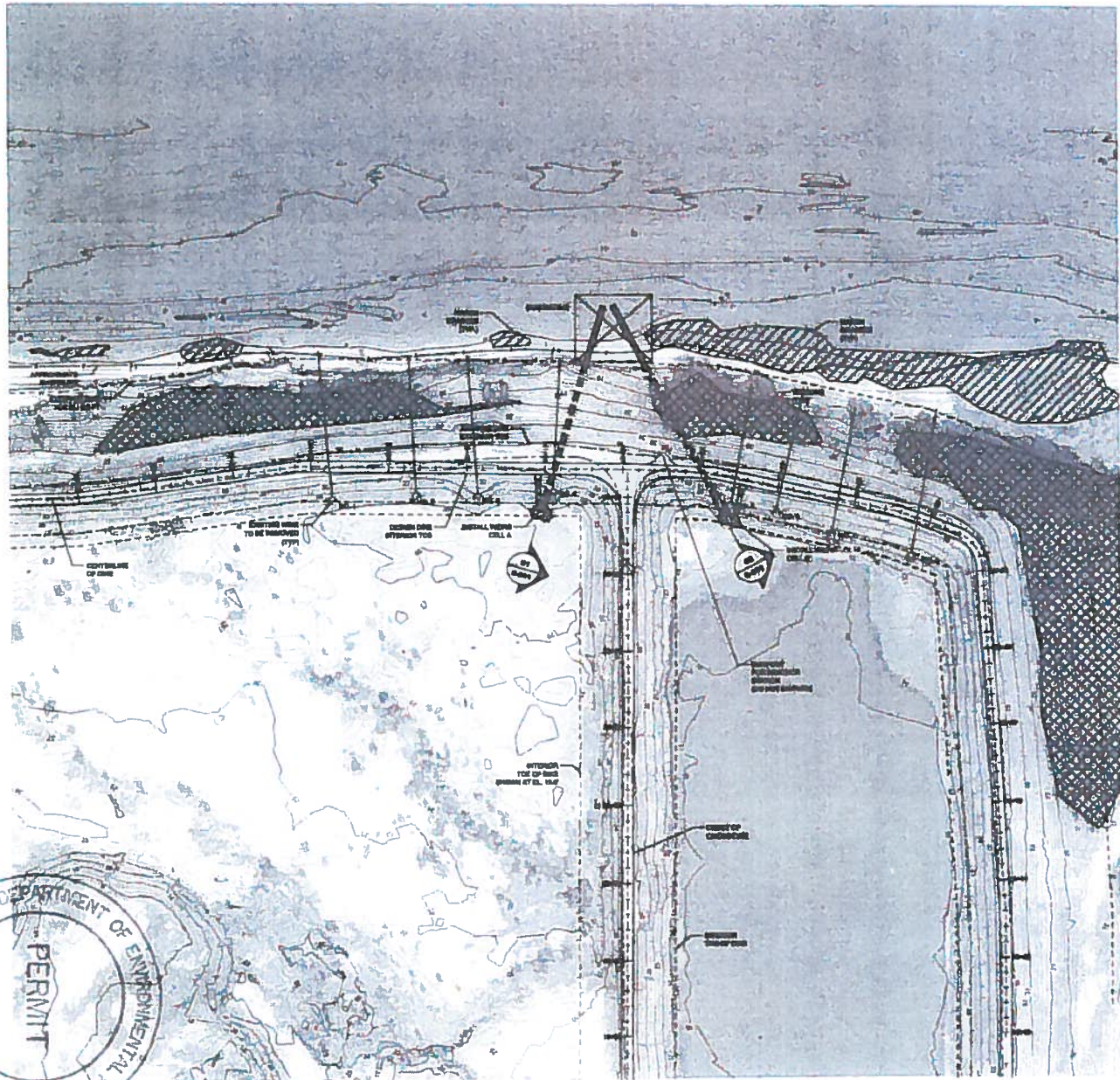

EXISTING AND PROPOSED WEIR LOCATIONS
SCALE AS SHOWN

NOTES:

1. SEE DWG. NO. C-101 FOR NOTES TO DRAWINGS, LEGEND, LOCATION AND VEGETY MAPS.
2. SEE DWG. NO. C-102 FOR CONTROL DATA.
3. SEE DWG. NO. C-101 FOR TOPOGRAPHIC SURVEY NOTES.
4. SEE THIS DRAW FOR WEIR SITE PLAN.
5. COORDINATES SHOWN ARE IN FEET AND ARE REFERENCED TO THE FLORIDA STATE PLANE COORDINATE SYSTEM, EAST COAST, NORTH AMERICA DATUM OF 1983, HSB ADJUSTMENT OF 1989 (PAD 838).
6. ALL DISTURBED AREAS ARE TO BE SUPERSEDED BY BEST PRACTICE (AND/OR OTHER APPROPRIATE BEST MANAGEMENT PRACTICE).
7. ALL EXISTING WEIRS AND CULVERT PIPES ARE TO BE REMOVED.
8. DUNE ALIGNMENT IN THE AREAS OF THE EXISTING WEIRS SHALL BE RECONSTRUCTED TO FOLLOW THE DESIGN.
9. INSTALLATION OF 8-INCHER PIPE EXTENSIONS NOT IN CONTRACT.



US Army Corps of Engineers
Wetlands Division

DATE	BY	REVISION

DESIGNED BY	DATE	SCALE
CHECKED BY	DATE	SCALE
APPROVED BY	DATE	SCALE
PROJECT NO.	DATE	SCALE
PROJECT NAME	DATE	SCALE
PROJECT LOCATION	DATE	SCALE

DEPARTMENT OF THE ARMY
CORPS OF ENGINEERS
WETLANDS DIVISION
ANN ARBOR DISTRICT
ANN ARBOR, MICHIGAN

PROJECT LOCATION
ANN ARBOR DISTRICT
ANN ARBOR, MICHIGAN

PROJECT NAME
ANN ARBOR DISTRICT
ANN ARBOR, MICHIGAN

PROJECT NO.
ANN ARBOR DISTRICT
ANN ARBOR, MICHIGAN

DATE
ANN ARBOR DISTRICT
ANN ARBOR, MICHIGAN

SCALE
ANN ARBOR DISTRICT
ANN ARBOR, MICHIGAN

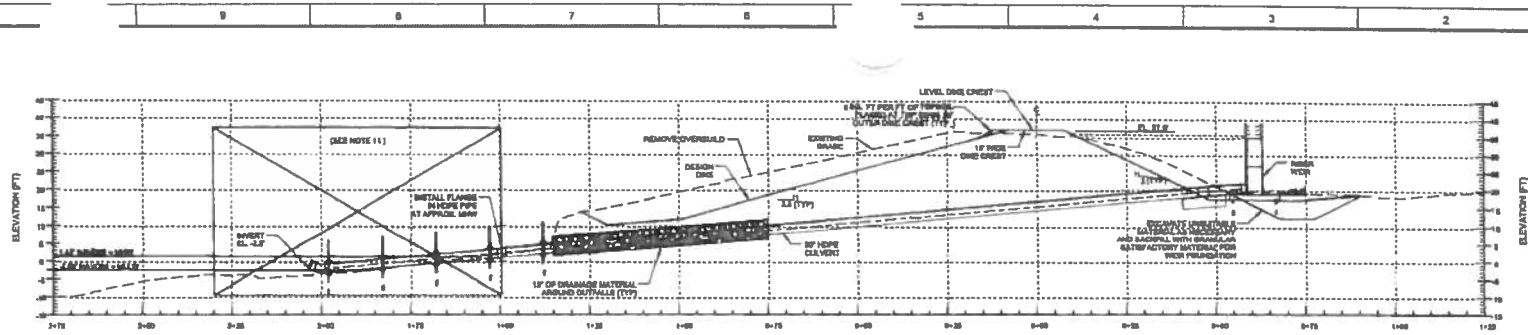

DESIGN WEIR CELL A - PROFILE
HORIZONTAL SCALE A
VERTICAL SCALE A

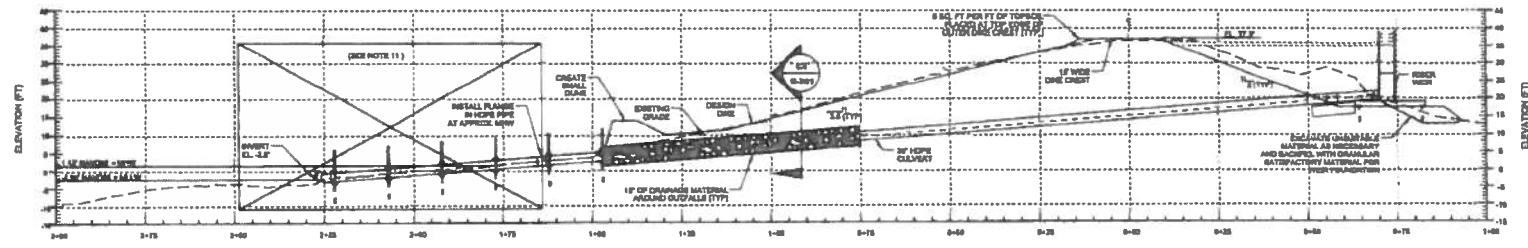

DESIGN WEIR CELL B - PROFILE
HORIZONTAL SCALE A
VERTICAL SCALE A

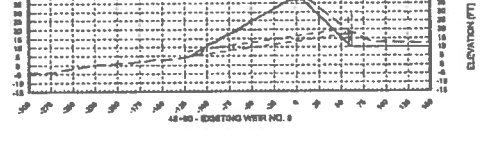
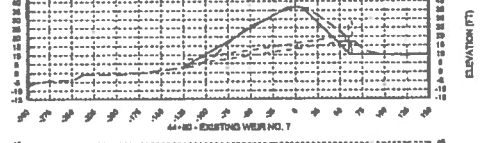
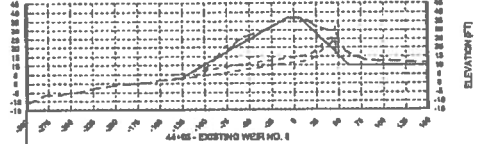
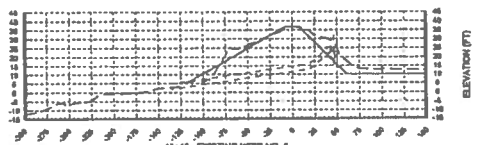
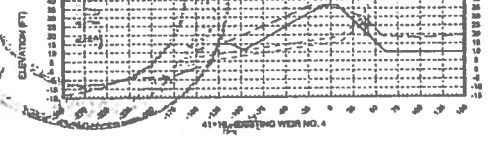
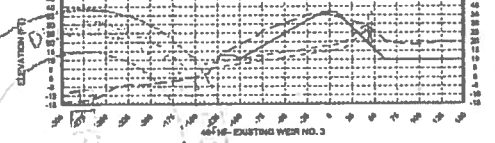
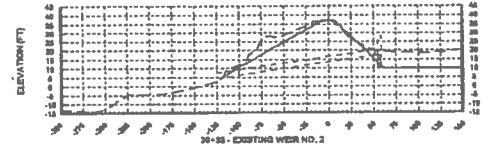
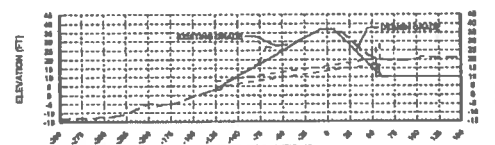

EXISTING WEIR - CROSS SECTIONS
HORIZONTAL SCALE A
VERTICAL SCALE B

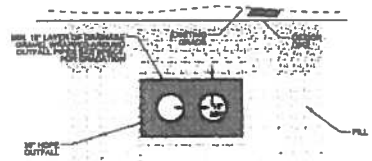

17\"/>

NOTES:

- SEE DWG. NO. 0-101 FOR WEIR TO DRAINAGE, LEGEND, LOCATION AND VICINITY MAPS.
- SEE DWG. NO. 0-106 FOR CONTROL DATA.
- SEE DWG. NO. C-101 FOR SURVEY NOTES.
- SEE DWG. NO. C-102 FOR WEIR SITE PLAN.
- SEE DWG. NO. C-103 FOR VERTICAL DIMENSIONS AND TYPICAL SECTIONS.
- ALL UNITS ARE IN US SURVEY FEET UNLESS OTHERWISE INDICATED AND ELEVATIONS ARE REFERENCED TO NAVD83.
- SEE DWG. NO. C-101 FOR DISE CENTERLINE STATIONING.
- EXISTING WEIRS SHOWN IN THE CROSS SECTIONS ARE APPROXIMATE PLANNIMETRIC FEATURES.
- ALL EXISTING WEIRS ARE TO BE REMOVED BY DEMOLISHING THIS DISE. IF THE DEMOLISHED MATERIAL IS TO BE REUSED IT MUST HAVE ALL ROCK AND DEBRIS GREATER THAN 1\"/>
- THE DISES IN THE AREA OF THE EXISTING WEIRS MAY HAVE A LARGER PERCENTAGE OF UNSATISFACTORY MATERIAL.
- THE BRACKET EXTENSION PIPE INSTALLATIONS ARE NOT PART OF THIS CONTRACT UNLESS THE PROCUREMENT OF ALL MATERIAL AND FURNISH OF THE PIPES ARE INCLUDED IN LINE ITEM NO. RETURN OUTFALL PIPES. THIS INCLUDES THE PIPING, CROSS BRACKS, HANDRAILS, PILING BRACKS, GATES, LIGHTS AND FLAP GATE. SMALLER ITEMS ARE TO BE STORED IN THE TO BE PROVIDED ON-SITE STORAGE CONTAINERS.



US Army Corps of Engineers
Alabama District

DATE	BY	CHKD BY	APP'D BY

PROJECT NO.	
DATE	
SCALE	
BY	
CHKD BY	
APP'D BY	
TITLE	

DESIGN OFFICE OF THE ARMY
CORPS OF ENGINEERS
JACKSONVILLE DISTRICT
JACKSONVILLE, FLORIDA

CONTRACT NO. W66101-67-0001
TASK ORDER NO. 1001
DRAWING NO. C-301
WEIR CROSS SECTIONS

DATE: 10/1/67
BY: J. L. BROWN
CHKD BY: J. L. BROWN
APP'D BY: J. L. BROWN

DRAWING NO. **C-301**

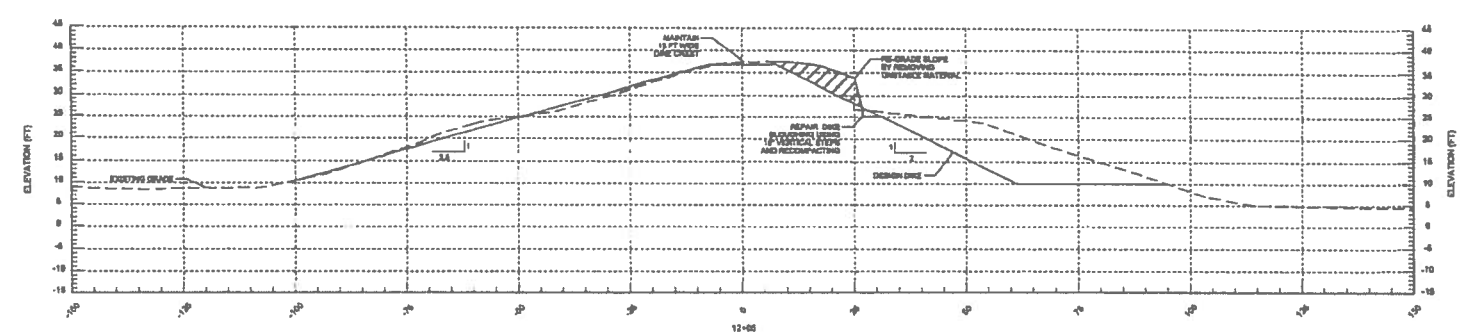

SLOPING AREA - CROSS SECTIONS
SCALE A

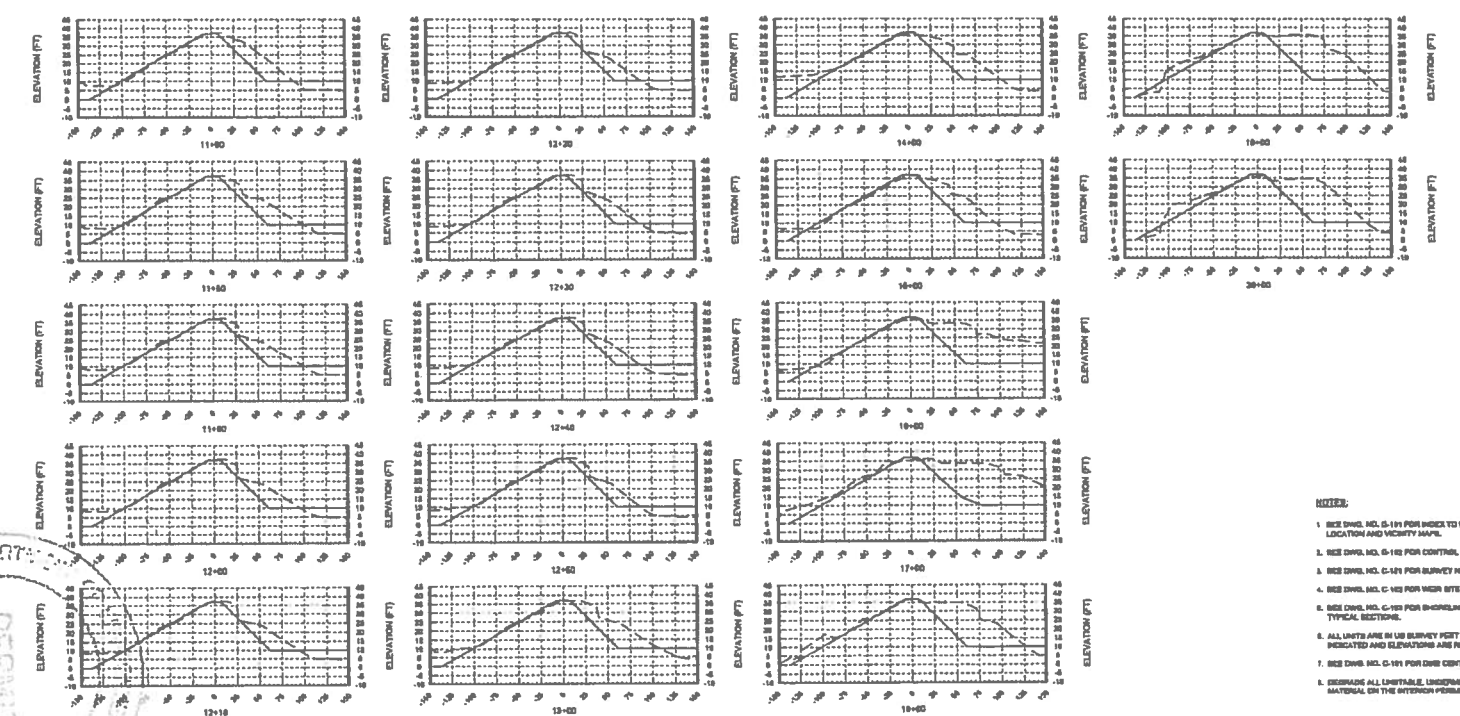

PERIMETER DNE SLOPING AREA - CROSS SECTIONS
HORIZONTAL SCALE B
VERTICAL SCALE C

- NOTES:**
1. SEE DNE, MD. G-111 FOR INDEX TO DRAWING, LEGEND, LOCATION AND VICINITY MAPS.
 2. SEE DNE, MD. G-102 FOR CONTROL DATA.
 3. SEE DNE, MD. G-101 FOR SURVEY NOTES.
 4. SEE DNE, MD. C-102 FOR HIGH WIND SITE PLAN.
 5. SEE DNE, MD. C-101 FOR SHORELINE ENHANCEMENT AND TYPICAL SECTIONS.
 6. ALL UNITS ARE IN US SURVEY FEET UNLESS OTHERWISE INDICATED AND ELEVATIONS ARE REFERENCED TO NAVD83.
 7. SEE DNE, MD. G-101 FOR DNE CENTERLINE STATIONING.
 8. FURNISH ALL SUITABLE, UNCOMPACTED AND UNCOMPACTED MATERIAL ON THE INTERIOR PERIMETER DNE SLOPES.

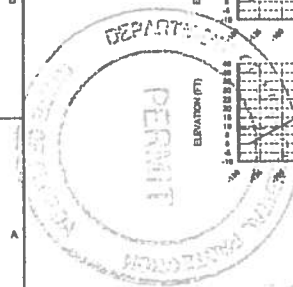
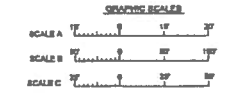

US Army Corps of Engineers Jacksonville District

DATE: 12/10/00

SCALE: 1" = 10'

PROJECT: PERIMETER DNE SLOPING AREA - CROSS SECTIONS

DESIGNED BY: C-303

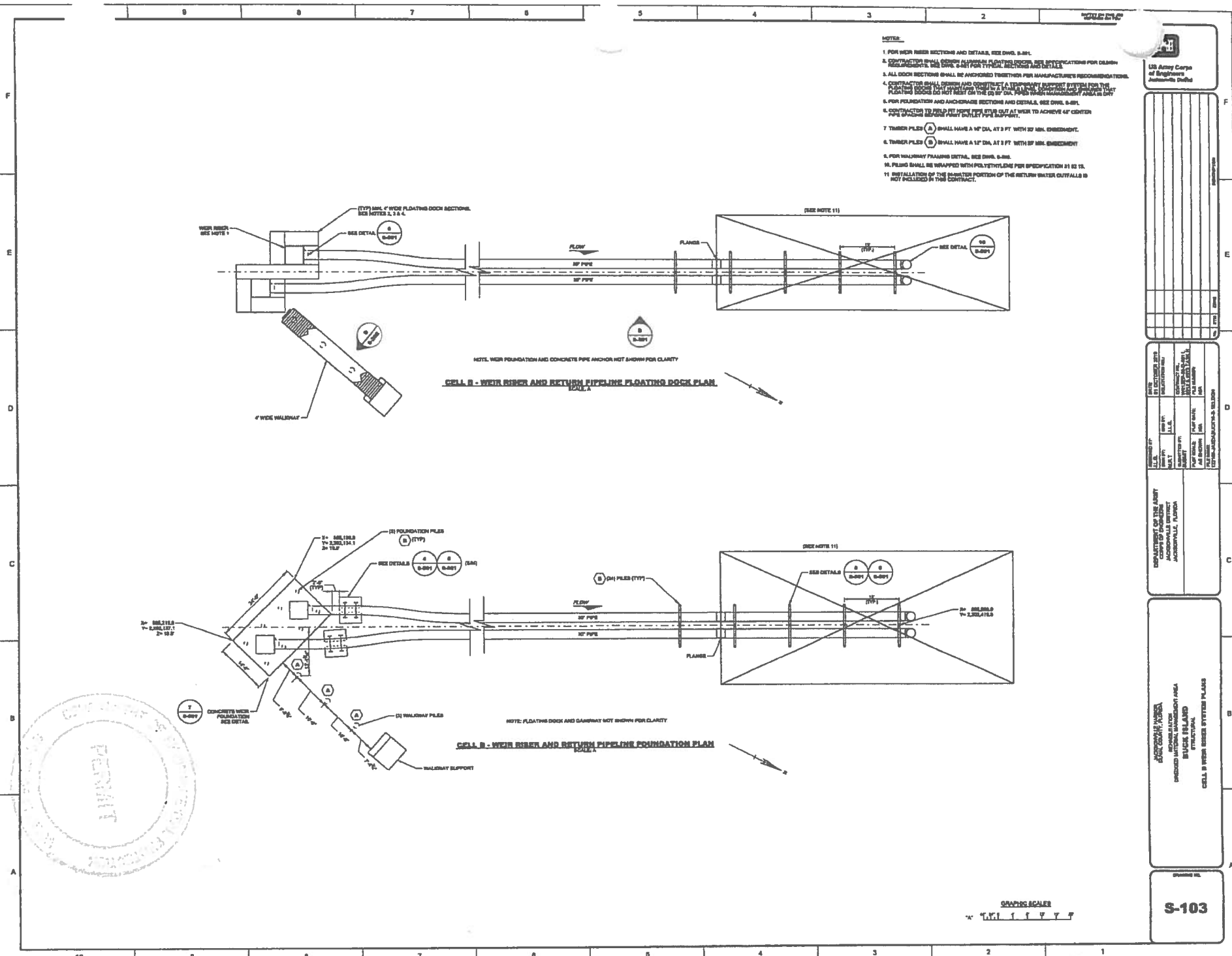

- NOTES:**
1. FOR WEIR RISER SECTIONS AND DETAILS, SEE DWG. S-891.
 2. CONTRACTOR SHALL DESIGN ALUMINUM FLOATING DOCKS. SEE SPECIFICATIONS FOR DESIGN REQUIREMENTS. SEE DWG. S-891 FOR TYPICAL SECTIONS AND DETAILS.
 3. ALL DOCK SECTIONS SHALL BE ANCHORED TOGETHER PER MANUFACTURER'S RECOMMENDATIONS.
 4. CONTRACTOR SHALL DESIGN AND CONSTRUCT A TEMPORARY ANCHORAGE SYSTEM FOR THE FLOATING DOCKS THAT SPREADS THE LOAD TO THE PERMANENT ANCHORAGE SYSTEM. THE FLOATING DOCKS DO NOT REST ON THE DOOR OR DOOR FRAME. THE ANCHORAGE SYSTEM SHALL BE DESIGNED TO WITHSTAND THE FULL WEIGHT OF THE DOCKS AND THE WEIGHT OF THE WATER.
 5. FOR FOUNDATION AND ANCHORAGE SECTIONS AND DETAILS, SEE DWG. S-891.
 6. CONTRACTOR TO FIELD FIT WALKWAY PILES TO ACHIEVE 48" CENTER-TO-CENTER SPACING. SEE DETAIL A.
 7. TIMBER PILES (A) SHALL HAVE A 4" DIA. AT 3 FT. WITH 30 MIN. EMBEDMENT.
 8. TIMBER PILES (B) SHALL HAVE A 12" DIA. AT 3 FT. WITH 30 MIN. EMBEDMENT.
 9. FOR WALKWAY FRAMING DETAILS, SEE DWG. S-891.
 10. PILING SHALL BE WRAPPED WITH POLYETHYLENE FOR SPECIFICATION S1 02 15.
 11. INSTALLATION OF THE DOWN-WATER PORTION OF THE RETURN WATER OUTFALLS IS NOT INCLUDED IN THIS CONTRACT.

CELL B - WEIR RISER AND RETURN PIPELINE FLOATING DOCK PLAN SCALE 1/4" = 1'-0"

CELL B - WEIR RISER AND RETURN PIPELINE FOUNDATION PLAN SCALE 1/4" = 1'-0"

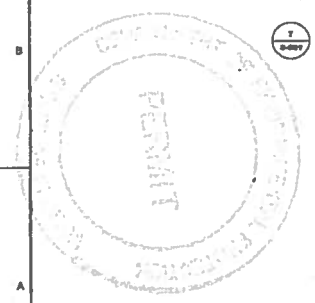

U.S. Army Corps of Engineers
Automatic Drafting

DATE	BY	CHKD BY	APP'D BY
10/15/88	J. L. B.	J. L. B.	J. L. B.

DESIGNED BY: J. L. B.
CHECKED BY: J. L. B.
DATE: 10/15/88

PROJECT: CELL B WEIR RISER SYSTEM PILING

SCALE: 1/4" = 1'-0"

S-103

GRAPHIC SCALE
1" = 10'-0"

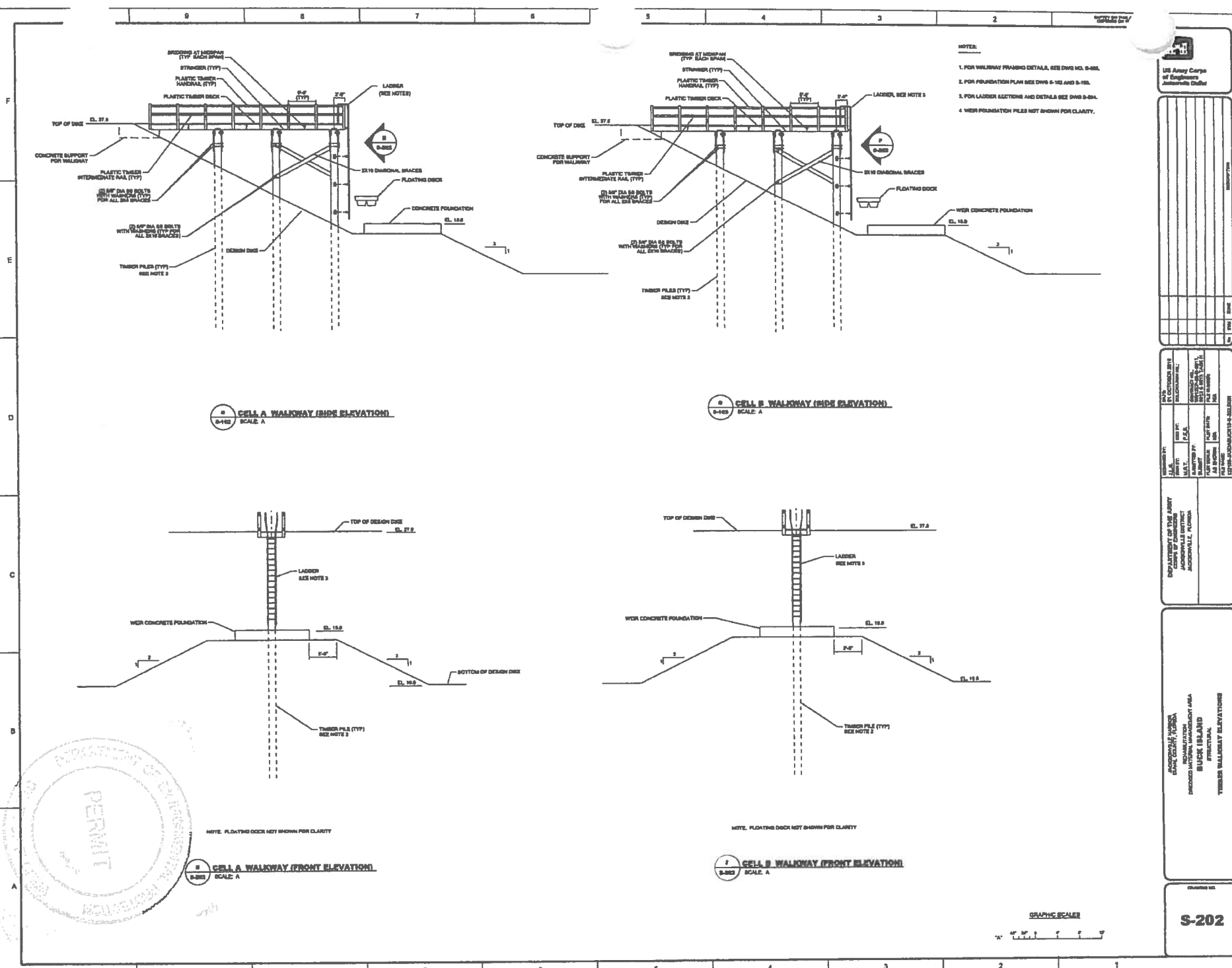

- NOTES:
1. FOR WALKWAY FRAMING DETAILS, SEE DWG NO. S-488.
 2. FOR FOUNDATION PLAN SEE DWG S-193 AND S-195.
 3. FOR LADDER SECTIONS AND DETAILS SEE DWG S-584.
 4. WALKWAY FOUNDATION PILES NOT SHOWN FOR CLARITY.

1 CELL A WALKWAY (SIDE ELEVATION)
SCALE: A

2 CELL B WALKWAY (SIDE ELEVATION)
SCALE: A

3 CELL A WALKWAY (FRONT ELEVATION)
SCALE: A

4 CELL B WALKWAY (FRONT ELEVATION)
SCALE: A

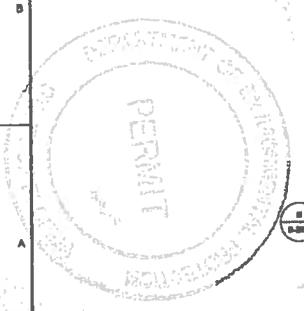

USE Army Corps of Engineers Standard Detail

DATE: 11 OCTOBER 1971	SCALE: 1/8" = 1'-0"
PROJECT: JACKSONVILLE DISTRICT	DESIGNED BY: [REDACTED]
CLIENT: U.S. ARMY	CHECKED BY: [REDACTED]
LOCATION: JACKSONVILLE, FLORIDA	APPROVED BY: [REDACTED]
CONTRACT NO. [REDACTED]	DATE: [REDACTED]

DEPARTMENT OF THE ARMY
ENGINEERING DISTRICT
JACKSONVILLE DISTRICT
JACKSONVILLE, FLORIDA

ENGINEER: [REDACTED]
DESIGNED: [REDACTED]
CHECKED: [REDACTED]
APPROVED: [REDACTED]
DATE: [REDACTED]

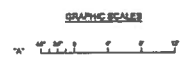

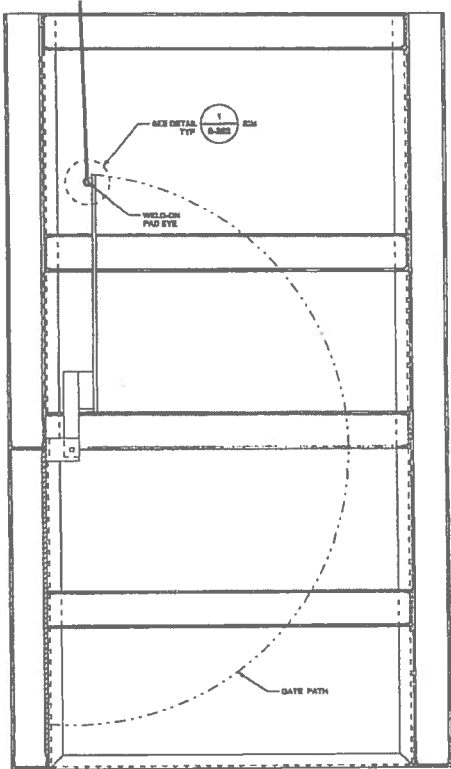

X GATE OPEN - LOWER SECTION
SCALE: NTS

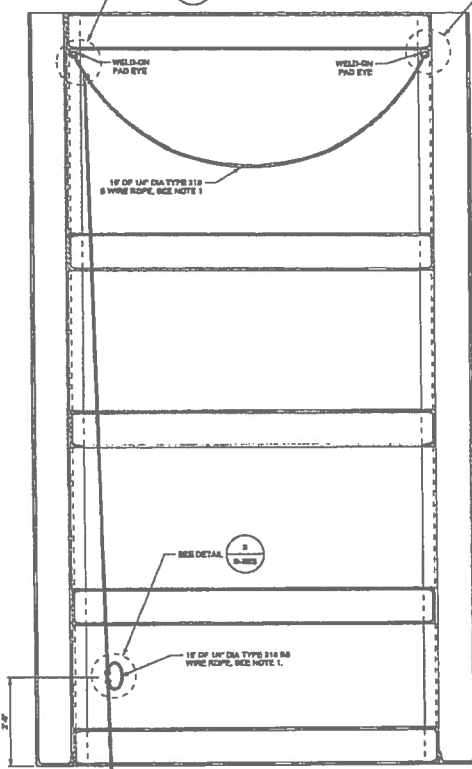

Y GATE OPEN - UPPER SECTION
SCALE: NTS

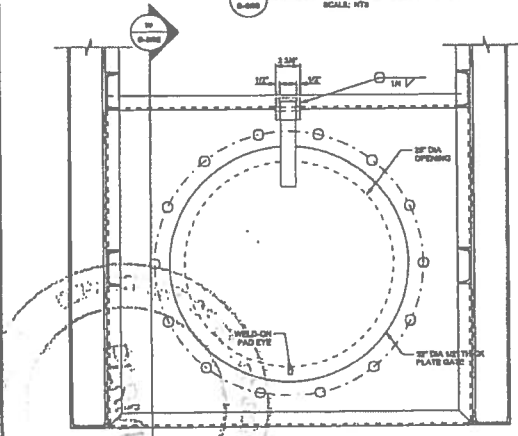

Z GATE CLOSED FRONT SECTION
SCALE: NTS

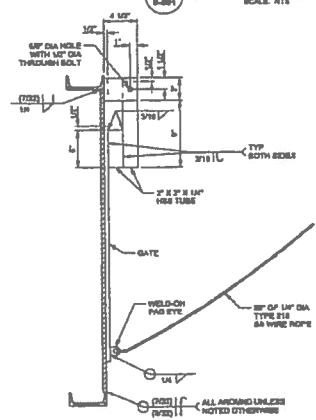

W GATE CLOSED SIDE SECTION
SCALE: NTS

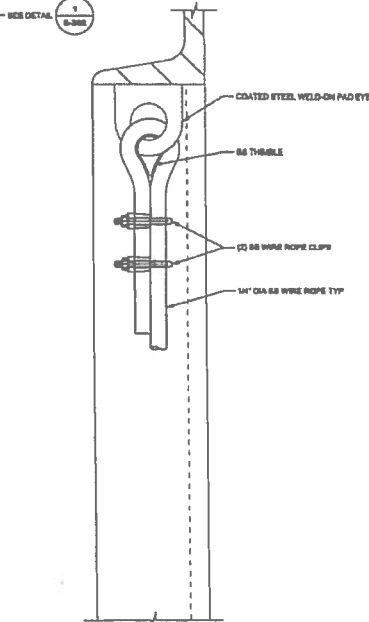

1 WIRE ROPE CONNECTION ASSEMBLY NO RELEASE
SCALE: NOT TO SCALE

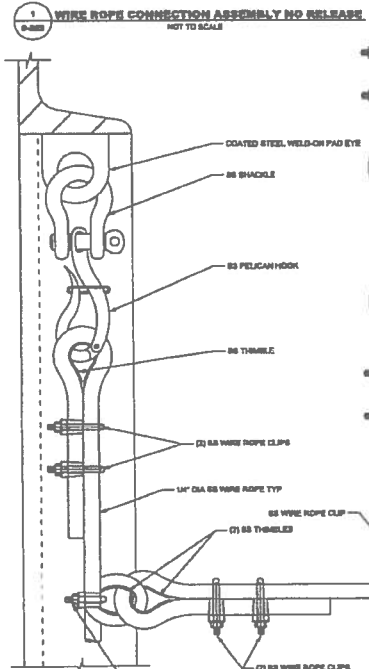

2 WIRE ROPE CONNECTION ASSEMBLY WITH RELEASE
SCALE: NOT TO SCALE

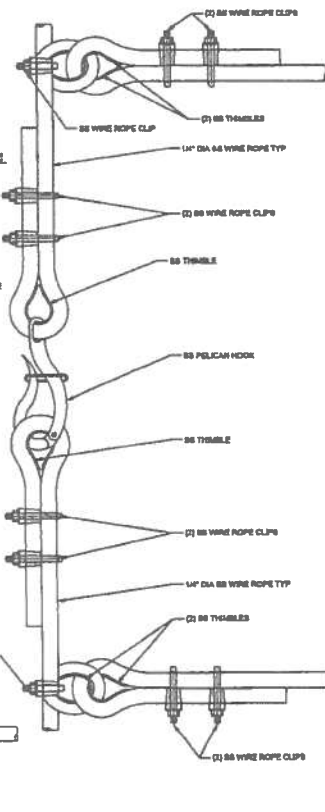

3 WIRE ROPE CONNECTION ASSEMBLY WITH RELEASE
SCALE: NOT TO SCALE

NOTES:
1. 88 WIRE ROPE LENGTHS DO NOT INCLUDE EXCESS ACCORD TO HANK LOOPS FOR CONNECTIONS.
2. COMPONENTS OF WIRE ROPE CONNECTION ASSEMBLY SHALL HAVE THIMBLE CAPACITY THAT MEETS OR EXCEEDS THE CAPACITY OF THE 1/4\"/>



US Army Corps of Engineers
Annapolis, MD

PROJECT NO.	
DATE	
BY	
CHECKED	
APPROVED	
DESIGNED	
DRAWN	
SCALE	
DATE	
BY	
CHECKED	
APPROVED	
DESIGNED	
DRAWN	
SCALE	
DATE	

PROJECT NO.	
DATE	
BY	
CHECKED	
APPROVED	
DESIGNED	
DRAWN	
SCALE	
DATE	

DEPARTMENT OF THE ARMY
CORPS OF ENGINEERS
WATERWAYS DIVISION
ANNAPOLIS, MARYLAND

ANNAPOLIS, MARYLAND
BLACK ISLAND
STRUCTURAL
ENGINEERING
CORPORATION

S-302

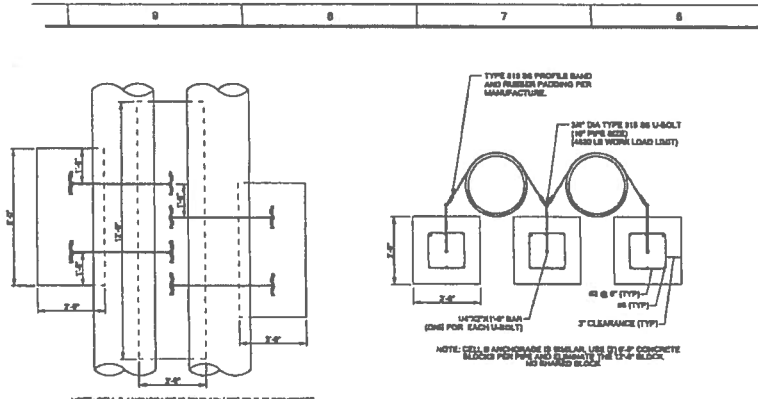

NOTE: CELL B ANCHORAGE IS SIMILAR, USE (1) 7'-0" CONCRETE BLOCKS PER PIPE AND (2) 12'-0" BLOCKS AND 8" WIDED BLOCKS.
CELL A - PIPE ANCHORAGE - DETAIL
 NOT TO SCALE

NOTE: CELL B ANCHORAGE IS SIMILAR, USE (1) 7'-0" CONCRETE BLOCKS PER PIPE AND (2) 12'-0" BLOCKS AND 8" WIDED BLOCKS.
CELL A PIPE ANCHORAGE - REINFORCING DETAIL
 NOT TO SCALE

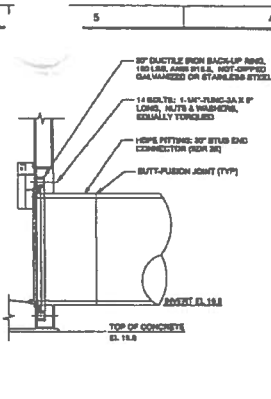

ATTACHMENT DETAIL
HOPE PIPE TO SPILLWAY RISER
 NOT TO SCALE

- NOTES:**
- FOR WEIR RISER DETAILS SEE DWG S-82.
 - FOR STEEL PLATE AND STRUCTURE LOCATIONS SEE DWG C-102.
 - ALL LIMBS USED IN THE MARINE ENVIRONMENT SHALL MEET AMERICAN WOOD PRESERVATION ASSOCIATION TREATED C11.
 - CONCRETE CLEAR COVER 4" UNLESS NOTED OTHERWISE.
 - ALL REINFORCING BARS CONFORM TO A31, S18 AND S4-82.
 - LAP SPICES SHALL BE CLASS B AND CONFORM TO THE REINFORCEMENT LENGTH TABLE ON SHEET B-102. ALL TOP BARS SHALL HAVE MORE THAN 12" OF CONCRETE BELOW SHALL HAVE THE EMBEDMENT DECREASED BY A FACTOR OF 1.2.
 - FOR FOUNDATION PLANS, SEE SHEETS S-102 AND S-103.
 - INSTALLATION OF THE 30-WATER PORTION OF THE RETURN WATER OUTFALLS IS NOT INCLUDED IN THIS CONTRACT.

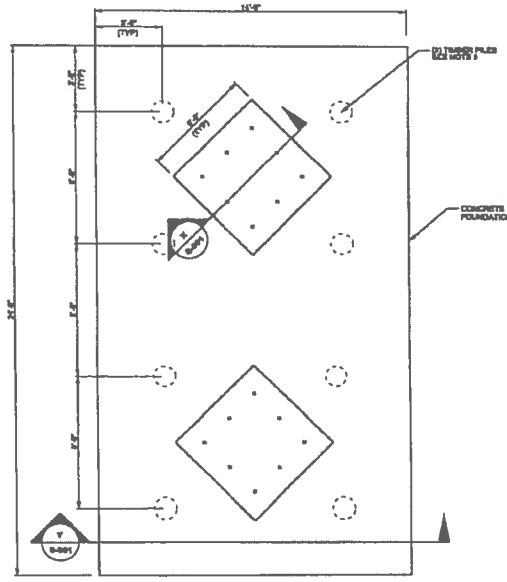

BASE PLATE AND FOUNDATION SLAB DETAILS
 NOT TO SCALE

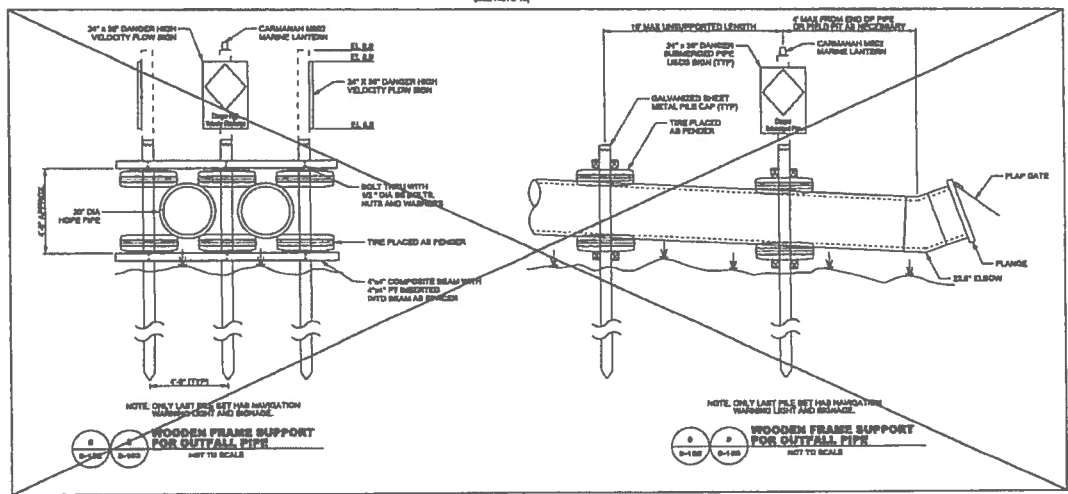

NOTE: ONLY LAST PIPE SET HAS IMAGINATIVE MARKINGS AND BRASSAGE.
WOODEN FRAME SUPPORT FOR OUTFALL PIPE
 NOT TO SCALE

NOTE: ONLY LAST PIPE SET HAS IMAGINATIVE MARKINGS AND BRASSAGE.
WOODEN FRAME SUPPORT FOR OUTFALL PIPE
 NOT TO SCALE

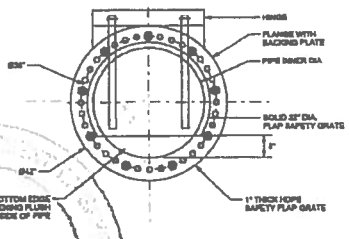

FLAP GRATE ASSEMBLY TO BE BOLTED TO THE END FLANGE WITH A MINIMUM OF 10 BOLTS.
OUTFALL FLAP GRATE
 NOT TO SCALE

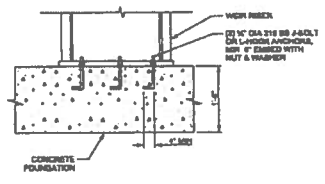

WEIR RISER ANCHORAGE
 NOT TO SCALE

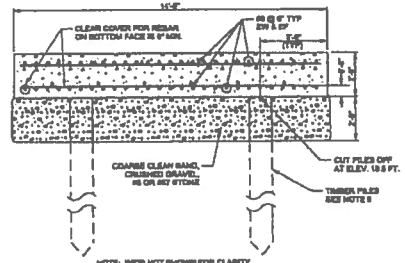

NOTE: WEIR NOT SHOWN FOR CLARITY.
WEIR RISER FOUNDATION
 NOT TO SCALE

US Army Corps of Engineers
 Hydrologic Engineering Center

NO.	DATE	BY	CHKD.	DESCRIPTION

DESIGNED BY	DATE	BY	CHKD.	DESCRIPTION
J.L.E.	10/11/82	J.L.E.	J.L.E.	DESIGN AND DRAWING
APPROVED BY	DATE	BY	CHKD.	DESCRIPTION

DEPARTMENT OF THE ARMY
 WASHINGTON DISTRICT
 JACKSONVILLE, FLORIDA

DESIGNED BY: J.L.E.
 DATE: 10/11/82
 BY: J.L.E.
 CHECKED BY: J.L.E.
 DATE: 10/11/82
 TITLE: WEIR RISER FOUNDATION AND DETAILS

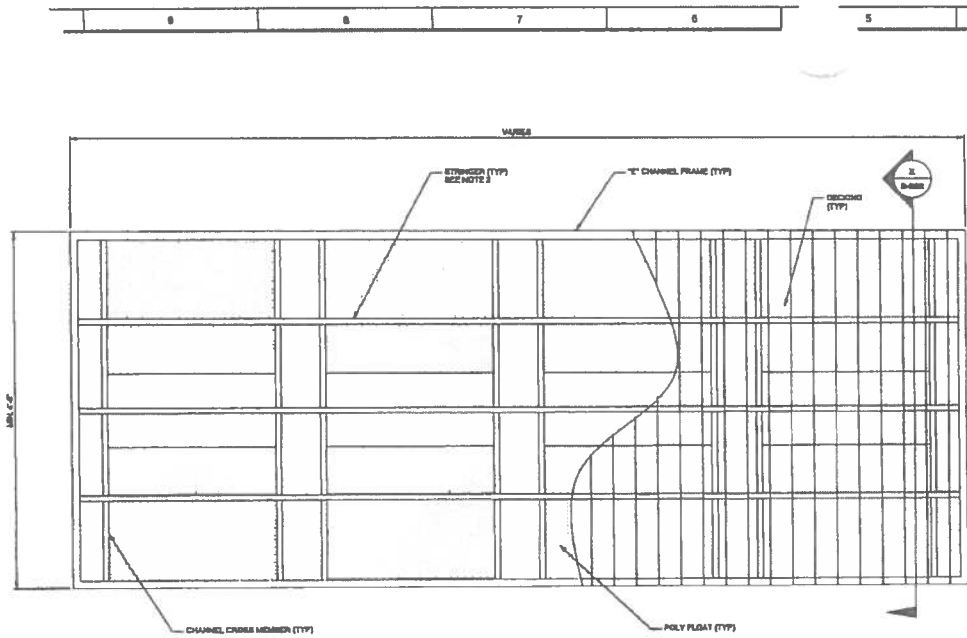

TYPICAL DOCK PLAN
NOT TO SCALE

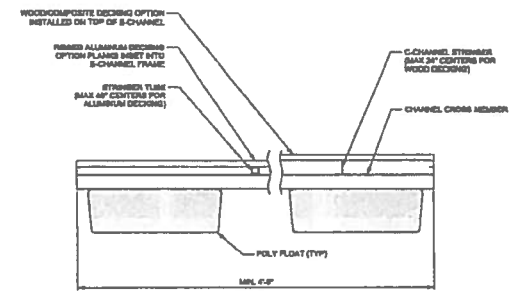

TYPICAL DOCK DETAIL
NOT TO SCALE

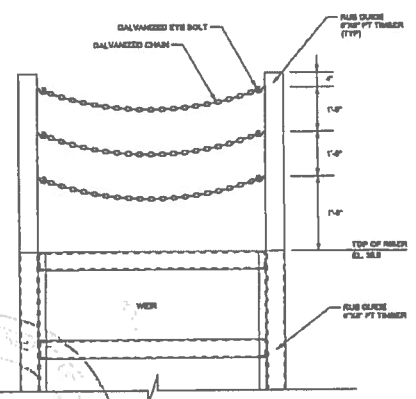

11 CHAIN - RUB GUIDE DETAIL (UPPER SECTION)
NOT TO SCALE

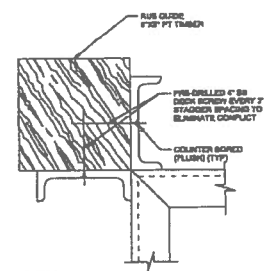

12 TYPICAL RUB GUIDE DETAIL
NOT TO SCALE

- NOTES:**
1. TYPICAL ALL (H) CORNERS OF BOTH WEIR.
 2. EXTEND FROM PULGATION TO 2" ABOVE TOP OF WEIR.

- NOTES:**
1. INITIAL GLESE PILES AS RECOMMENDED BY THE DOCK MANUFACTURER. USE WEIR RIBBER AND DOCK DIMETRY AS GLAZE WERE POSSIBLE. ENSURE FUNCTION OF FLOATING DOCK DOES NOT EFFECT THE COATING ON THE WEIR. ENSURE ALL FLOATING DOCK SECTIONS ARE SECURELY ANCHORED TO ONE ANOTHER.
 2. STRISSER SECTIONS DEPEND ON TYPE OF DECKING.
 3. SEE DWG S-102 & S-103 FOR CONCEPTUAL FLOATING DOCK LAYOUT.

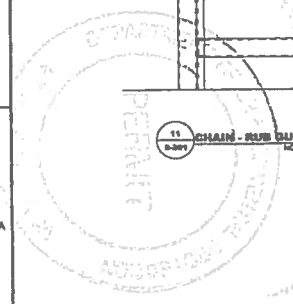

U.S. Army Corps of Engineers Jacksonville Office

NO.	DATE	BY	CHKD.	APP.

DESIGNED BY	DATE	SCALE	PROJECT NO.
CHECKED BY			
APPROVED BY			

DEPARTMENT OF THE ARMY
ENGINEERING DISTRICT
JACKSONVILLE, FLORIDA

JACKSONVILLE WATERWAYS DISTRICT
JACKSONVILLE, FLORIDA

PROJECT NO. S-502

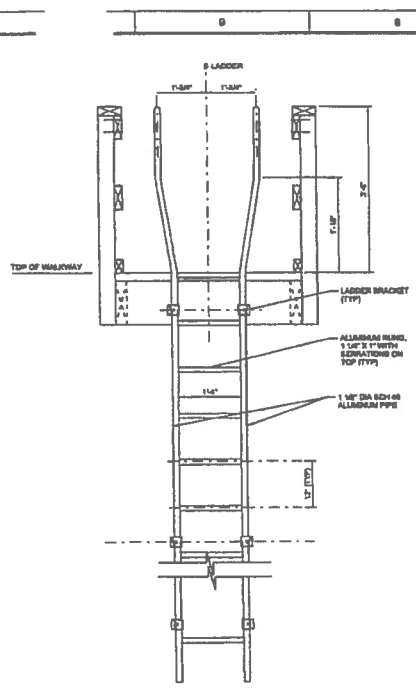

21 LADDER - FRONT ELEVATION
SCALE: NTS

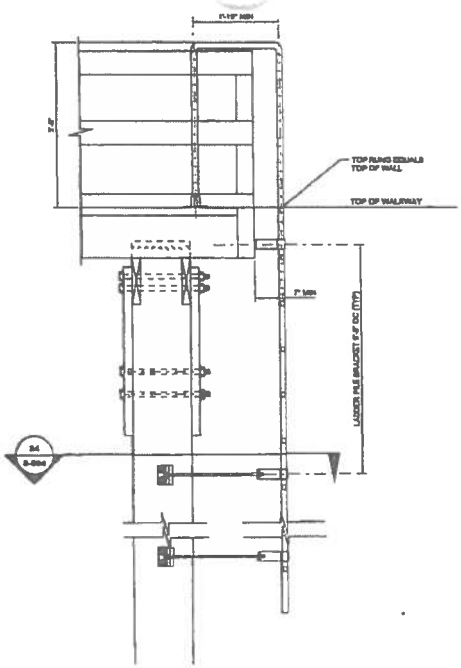

22 LADDER - SIDE ELEVATION
SCALE: NTS

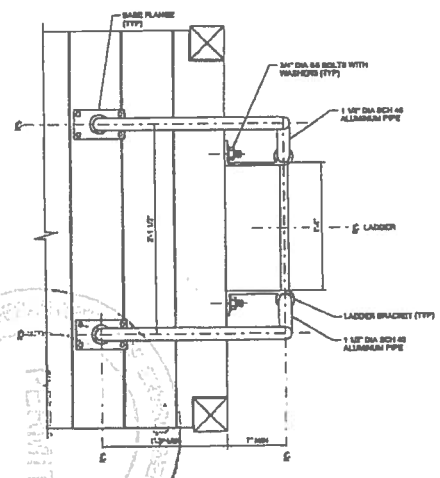

23 LADDER - PLAN
SCALE: NTS

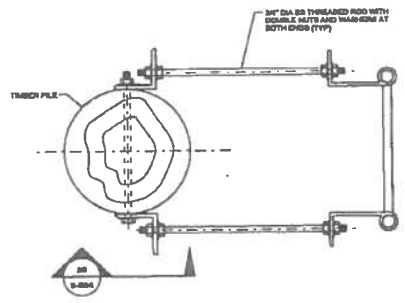

24 LADDER - PLAN
SCALE: NTS

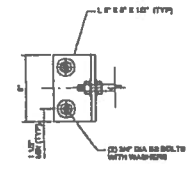

25 LADDER - SECTION
SCALE: NTS

- NOTES:**
1. DIMENSIONALIZATION, 28 CFR 191.637, FIXED LADDERS IS APPLICABLE.
 2. PROVIDE ALUMINUM LADDERS WITH STANDARD MIL FINISH.
 3. USE 3/8\"/>
 - 4. INSTALL LADDERS ACCORDING TO MANUFACTURER'S INSTRUCTIONS.
 - 5. FOR WALKWAY FRAMES DETAIL, SEE DWG NO. S-507.
 - 6. END ANGLE OF WALKWAYS FOR LADDERS TO BE FIELD FIT TO ALIGN WITH PLATING EDGES.

US Army Corps of Engineers
Annapolis District

ENGINEER OF THE ARMY
CORPS OF ENGINEERS
DISTRICT OFFICE
ANNAPOLIS, MARYLAND

DESIGNED BY
STRUCTURAL AREA
LADDER SECTIONS AND DETAILS

Buck Island Operations Plan

January 2011

1 References

- 1.1 EM 1110-2-5027 (available on-line at <http://140.194.76.129/publications/eng-manuals/em1110-2-5027/toc.htm>)
- 1.2 Final Trip Report dated 30 April 2010
- 1.3 Storm Water Hydrographs
- 1.4 Buck Island Weir Repairs, Seepage and Slope Stability Analysis dated October 2010
- 1.5 Interim Dredged Material Management Plan with Environmental Report dated June 2005; excerpt Table 7: Jacksonville Harbor Operation & Maintenance Responsibilities/Cost – Disposal Area

2 Introduction

2.1 The Buck Island Operations Plan has been developed to provide a management guide for the existing site, which is utilized by the Corps of Engineers (Corps) and JaxPort for the maintenance of the federal navigation channel and berthing areas. This plan provides guidelines for operation and maintenance of the disposal area during all phases of operation.

2.2 DMMA's may be designed and constructed by the Corps, the Project Sponsor of the federal project (such as JaxPort), or some other Federal agency, such as the Air Force, Navy, Coast Guard, etc. Ongoing routine maintenance of the DMMA is typically a shared responsibility of the Project Sponsor and the Corps as described in the Interim DMMP for Jacksonville Harbor dated June 2005 (reference 1.5, Table 7 on pages 15 and 16). The Corps uses EM 1110-2-5027 (reference 1.1) as a guideline for all aspects of DMMA design, construction, maintenance, and operation.

2.3 This Operations Plan strives to present a comprehensive description of activities and events that have brought us to the present moment and that are planned for the future. These activities and events have been and will be initiated either by the Project Sponsor or the Corps.

3 Background

3.1 The Buck Island DMMA has been operated in support of the Jacksonville Harbor navigation project for more than fifty years. The site is divided into two individually operating cells. Cell A is approximately 63.1 acres and Cell B is approximately 34.2 acres. The date of original spoil placement at Buck Island is not known; however, in 1989, the USACE constructed dikes on Buck Island that match the current approximate outer dike toe footprint. In 1997, the Port of Jacksonville raised the dikes again to their present elevation of 37-ft NAVD. Current spoil capacities for Buck Island¹ have been estimated at approximately 1,257,000 cubic yards in Cell A and 964,000 cubic yards in Cell B.

3.2 Current Status

The document titled Final Trip Report dated 30 April 2010 (reference 1.2) describes the operational status of Buck Island Cell A and Cell B prior to start of the most recent Jacksonville Harbor dredging events in the summer of 2010. The trip report notes certain deficiencies in the visible portions of the weir systems and the repairs required. The repairs were made prior to start of dredging. Dredging and disposal operations commenced at Buck Island Cell A in early June 2010. On the morning of 7 June 2010, after the water level in the cell had risen above the base of the weirs, the dredge contractor (Great Lakes Dredge and Dock, Inc) noticed water leaking around the outside of the weir outfall pipes where the pipes

¹ RS&H Survey dated December 2009

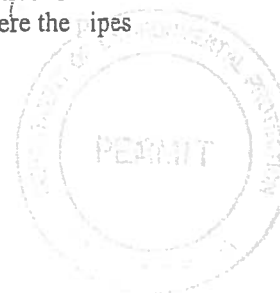

exited the exterior face of the dikes. The contractor took immediate action to stop flow through the weirs. As the situation developed, it became apparent that water was leaking from the weir outfall pipes, into the dike structure and then out to the exterior face of the dikes.

3.3 As a result of the above situation in Cell A, all dredging activities for Cell A were discontinued and the cell is now considered non-operational until the old weirs are removed and replaced. Although Cell B weirs have not leaked, they were of the same design and were installed at the same time as the Cell A weirs; so the Corps and JaxPort have determined that Cell B is also non-operational until the old weirs are removed and replaced.

3.4 As of the writing of this operations plan the Corps is preparing contract plans and specifications for weir replacement and dike repairs at Buck Island Cell A and Cell B. The weir replacement and dike repairs will be accomplished prior to the next placement of dredged material at Buck Island.

4 Design Analysis

4.1 Freeboard – General

General freeboard requirements for upland DMMA's are provided within Corps guidance in EM 1110-2-5027 (reference 1.1, paragraph 4.3.b(3)(a) on page 4-8). Although detailed freeboard criteria for dams and other large water impounding areas do exist, these Corps criteria are reserved for large reservoirs where overtopping due to wave setup and run-up is primarily dependent on depth and effective fetch length. DMMA's are typically not representative of reservoir conditions, since ponding depths during and after dredged material placement are relatively shallower, and overall fetch lengths are significantly shorter. As such, a freeboard of 2 feet is recommended in Section 4.3 of EM1110-2-5027.

4.2 Freeboard – Operational Requirements

Under all conditions the freeboard in both Cells A and B should be maintained at no less than 2 ft. Wave run-up analyses indicate that (for both Cell A and Cell B) a drawdown will have to occur when sustained wind speeds are forecast to be in excess of 60 mph. Based upon the results depicted in the Report titled "Dredged Material Management Area Embankment Freeboard Analysis August 2007", when water depth is 2 feet or less a freeboard of 2.5 ft should be created to withstand the effects of a 110 mph design storm. A water depth of greater than 2 feet will require 4 ft of freeboard to withstand the effects of a 110 mph design storm without damage to the dikes. Prior to the arrival of storm force winds the dredging contractor will be required to create the necessary freeboard by drawing down the water.

4.3 Storm Water Analysis 25-year / 24-hour

A storm water analysis was performed using HEC RAS Version 4.1 (reference 1.3). The inflow parameter for the model is the 25-year / 24-hour storm event hydrograph (9.5 inch total rainfall). The outflow parameters assume that the initial water elevation is at 35 feet NAVD88 (corresponding with the 2-foot freeboard requirement), the weir riser boards are set at 32 feet NAVD88 and that the total weir crest length is 32 feet for each weir set (one weir set in Cell A and one in Cell B). Each weir set is drained by a pair of 30 inch HDPE weir outfall culverts. The model results indicate a peak flow velocity of 19 fps in the weir culvert pipes and a maximum 2-foot drawdown time of 9.75 hours.

4.4 Draw Down Discharge

Based on the 25-year / 24-hour storm analysis, the time to drawdown 2 feet of water from elevation 35 feet NAVD88 to elevation 33 feet NAVD88 is approximately 9.75 hours for Cell A and 4.75 hours fo

Cell B. Emergency drawdown of water within the DMMA will create 4 feet of freeboard once a Gale, High Wind, or Tropical Storm Warning is issued for the region.

4.5 Water Elevation

During dredging, when the water elevation within either cell is above elevation 30 ft NAVD88, dike inspection frequency should be increased to every 4 hours, see paragraph 7.2 Inspections During Dredging, below.

4.6 Geotechnical Data

Recent geotechnical investigations were performed at the site in support of the weir replacement and dike repair contract. Details of the investigation as well as a description of the subsurface conditions encountered and the geotechnical analysis performed to ensure structural and geotechnical stability of the DMMA are discussed below.

4.6.1 Seepage and Slope Stability

Field investigations, laboratory testing, seepage, and slope stability analyses were performed for the DMMA at Buck Island. When the interior water level of the cell was modeled at the highest level permitted (35 feet NAVD88) the lowest seepage factor of safety (FOS) calculated for the horizontal gradient was 1.74 and the highest FOS calculated was 2.03. Under the same conditions the lowest FOS calculated for the vertical gradient was 2.7 and the highest FOS was 3.35. The FOS for slope stability were in the range of 1.244 to 1.649 for surficial stability and 1.601 to 1.789 for global stability. The full results of the seepage and slope stability analyses are included in the Memorandum For Record – Buck Island Weir Repairs, Seepage and Slope Stability Analysis, dated October 2010 (reference 1.4).

5 Placement of Material

5.1 During placement of dredged material in the disposal area, constant radio communication between the dredge and disposal area personnel shall be maintained. Water elevation should be maintained no higher than 2 feet below the minimum dike crest elevation. Water height shall be constantly monitored while pumping to ensure the 2 feet freeboard is maintained.

5.2 Discharge Location

In order to allow for the longest possible flow path, dredged material should be discharged into Buck Island along the southwest side of the DMMA which is the upstream end of Cell A and Cell B. As such, the flow path length will be approximately 2000 feet for Cell A and 2200 feet for Cell B. Discharge pipe location may be moved as necessary along the southwest dike to prevent mounding of material.

6 Weir Operations

6.1 From commencement of dredging, the operation of the weir system needs to be managed to minimize the return of suspended solids and associated turbidity to the receiving water body to meet contract and permit requirements. The dredging contractor, with oversight provided by the contractor's quality control manager and the Corps' quality assurance representative, will monitor and manage the dredge output and the weirs to control water elevation, ponding depth, dredge inflow rate, and other parameters to maintain effluent discharge from the DMMA at or below required turbidity standards. Weir stacks should be fully operational during all phases of the dredging operation and the weir crests should be maintained a equal

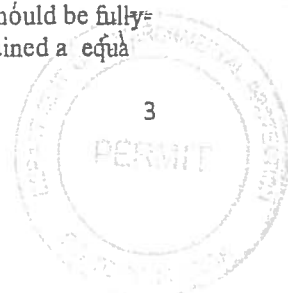

elevations with essentially equal flow over the weirs, unless approved by the Contracting Officer in writing. Note that in the special case where placement of dredged material is accomplished without discharge (typical of JaxPort dredging projects), the weirs should be sealed by closing the flap gate and the weir riser boards should be placed to the maximum elevation.

6.2 Minimum Ponding Depth

EM 1110-2-5027 (reference 1.1, paragraph 4.3.a on page 4-5) establishes 2-feet as the minimum operational ponding depth to be used during normal dredging operations. The dredging contractor may choose to use a ponding depth greater than 2-feet at his discretion. For the Buck Island DMMA, the minimum ponding depth of 2-feet should be maintained, unless an emergency drawdown is necessary or final decanting operations are underway.

6.3 Maximum Ponding Depth

Unless otherwise established in the dredging contract specifications, the maximum ponding depth will be controlled or limited by the water elevation necessary to meet the minimum required freeboard.

6.4 Weir boards

The weir boards specified for use at Buck Island DMMA are of the lightweight composite material type. This type of weir board provides a good water seal to deter leakage between and around the weir boards. The individual boards are much lighter and easier to install and remove than equivalent size wooden weir boards; yet, since they are hollow, they have the advantage that they sink and are therefore not subject floating up and becoming dislodged.

6.5 Lighting

Weir stacks and surrounding area shall be lighted during night-time operations. All lighting shall be in accordance with the USACE Safety and Health Requirements Manual (EM 385-1-1).

6.6 Night-time Visual Monitoring

During night-time operations or any other period when turbidity monitoring is not active, the contractor shall visually monitor the water flow over and through the weirs for any signs of elevated turbidity. Any visual indication of elevated turbidity shall be immediately reported to the Quality Control Manager.

6.7 Decanting

After dredging is complete, the incremental removal of weir boards aids in the slow release of the clarified surface water from the basin over the weir crest. The process of decanting continues after dredging is complete until all residual ponded water is released over the weirs. During decanting, the weirs will be actively managed to meet turbidity standards and minimize the return of suspended solids and associated turbidity to the receiving water body.

7 Site Maintenance and Management

7.1 Dike Repairs



The contract requirements listed below are typical of dike embankment specifications which will be used for the Buck Island Rehabilitation Project. The text may be modified slightly to address specifics of this particular project but the compaction requirements should remain as referenced below.

7.1.1 Compaction of Embankment Material

Material shall be placed in 12-inch uncompacted lifts, once a 12-inch layer of material has been dumped and spread, it shall be harrowed to break up and blend the fill materials and to obtain uniform moisture distribution. Harrowing shall be performed with a heavy disk plow, or other approved harrow, to the full depth of the layer. If one pass of the harrow does not accomplish the breaking up and blending of the materials, additional passes of the harrow shall be required, but in no case will more than three passes of the harrow on any one layer be required for this purpose. When the moisture content and the condition of the layer are satisfactory, the lift shall be compacted to a minimum of 95 percent of the maximum dry density as determined by the Contractor in accordance with ASTM D 1557. Dumping, spreading, sprinkling, and compacting may be performed at the same time at different points along a section when there is sufficient area to permit these operations to proceed simultaneously. Compaction equipment shall be operated such that the strip being traversed by the roller shall overlap the rolled adjacent strip by not less than 3 feet.

7.1.2 Materials Testing

Perform sufficient testing to insure that the fill is being constructed as specified. The testing program specified below shall be considered the minimum acceptable frequency of testing. This does not relieve the Contractor from the responsibility of performing additional testing, if required to ensure compliance with these specifications.

a. Soil Classification Tests:

Soil classification tests shall be performed in accordance with ASTM D 2487. One initial classification test shall be required for each different classification of material to be utilized as embankment fill or backfill. As prescribed in ASTM D 2487, grain size analyses in accordance with ASTM D 422 and Atterberg limits in accordance with ASTM D 4318 shall be performed on each different classification. Submit additional tests for every 5000 cubic yards of embankment or backfill material. Soil classification tests shall be performed on foundation material as required to determine the acceptability of the in-situ soils. Additional tests will be required if noticeable changes in the material occur.

b. Cohesionless Material Testing

(1) Compaction Tests- Run not less than one modified maximum dry density test for every 3000 cubic yards of cohesionless fill in accordance with ASTM D 1557.

(2) In-Place Density Tests- The in-place density of the cohesionless materials shall be determined in accordance with ASTM D 6938. Run not less than one (1) field in-place density test on each lift of material every 300 feet of the embankment length or every 500 cubic yards of completed embankment fill or backfill whichever is less. Horizontal locations shall be randomly staggered in the fill. When nuclear method is used for in-place density testing according to ASTM D 6938, the first test and every tenth test thereafter for each material type shall include a sand cone correlation test in accordance with ASTM D 1556.

The sand cone test shall be performed adjacent to the location of the nuclear test, and shall include a nominal 6 inch diameter sand cone, and shall include a minimum wet soil weight of 6 pounds extracted from the hole. The density correlations shall be submitted with test results. Each

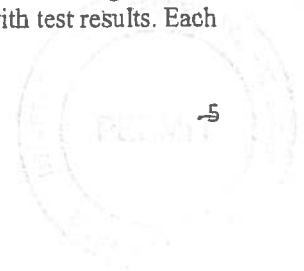

transmittal including density test data shall include a summary of all density correlations for the job neatly prepared on a summary sheet including at a minimum:

- (i) Meter serial number and operators initials.
- (ii) Standard count for each test.
- (iii) Material type.
- (iv) Probe depth.
- (v) Moisture content by each test method and the deviation.
- (vi) Wet density by each test method and the deviation.

(3) Water (Moisture) Content Tests- Determination of water content shall be performed in accordance with ASTM D 2216.

ASTM D 4643 may be used when rapid moisture content results are needed. All rapid results obtained by ASTM D 4643 shall be confirmed by a test on a duplicate sample performed in accordance with ASTM D 2216. In the event of disagreement between the results, ASTM D 2216 shall govern. One water content test will be performed for each 2000 cubic yards of material placed or each lift of material whichever is less.

7.1.3 Grouting

Prior to commencement of dredging, gopher tortoise burrows and any hole with a diameter six inches or large and deeper than two feet or more within the dike shall be identified and clearly marked. All holes meeting this criteria will be grouted. Any holes that do not meet this criteria shall be filled at the surface by filling with clean sand and compacting to original grade. All gopher tortoises will be relocated prior to grouting and any construction activity.

7.1.4 Grassing

Seeding to obtain a healthy stand of permanent grass plants will begin on the first day of seeding work required under this contract, shall continue through the remaining life of the contract, and end 3 months after the last day of the seeding operation required by this contract or until a satisfactory stand of grass plants is obtained, whichever is later. Written calendar time period shall be furnished for the seed establishment period. When there is more than 1 seed establishment period, the boundaries of the seeded area covered for each period shall be described. The seed establishment period shall be modified for inclement weather, shut down periods, or for separate completion dates of areas. Permanent grass plants shall be evaluated for species and health when the grass plants are a minimum of 1 inch high. A satisfactory stand of permanent grass plants from the seeding operation shall be a minimum of 20 grass plants per square foot. Bare spots shall be a maximum of 9 inches square. The total bare spots shall not exceed 10 percent of the total seeded area.

7.2 Inspections During Dredging

Dike inspection shall be performed twice daily of the entire perimeter of the dike crest and slopes of the disposal area including 50-feet beyond the exterior toe of the slope. If any critical conditions become apparent and upon confirmation by USACE or JaxPort, the frequency of inspections shall be increased to a minimum of four times daily until a remedial action is performed. The inspection shall document any occurrences of the following:

- a. Seepage on outer face or downstream from the toe in which there are boils, sand cones, or deltas.
- b. Silt or sand accumulations, boils, deltas, or cones in the drainage ditches at the base of the dikes.

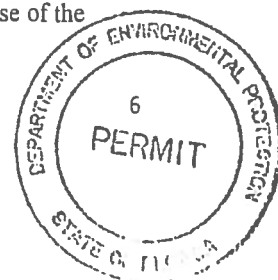

- c. Cracking of soil surface on crest or either face of the dike.
- d. Serious erosion of any dike surface.
- e. Bulging of the exterior face of dike.
- f. Seepage, damp areas, boils, or erosion near weir structure or outfall pipes, especially in the vicinity where the outfall pipes exit the exterior slope of the dikes.
- g. Any subsidence of the dike crest or faces.
- h. Any deficiencies in the weir structure system that can be detected by visual inspection.
- i. Any changes in dike vegetation on the crest, interior slope, exterior slope and fifty feet beyond the exterior toe of slope.

7.3 Offloading

Several off-loading plans are under consideration by JaxPort and the Corps. Off-loading will extend the useful life of the disposal cell(s) as sandy and other types of soil are removed from Cell A and/or Cell B during periods when the cells are not active. Off-loading alternatives include:

- Direct beach placement at Mayport
- Nearshore placement at Mayport
- Ocean placement at Jacksonville ODMDS
- Ocean placement at Fernandina ODMDS
- Direct truck haul from Buck Island for construction project fill material
- Barge haul from Buck Island for construction project fill material

Testing of material prior to off-load would be on an as necessary basis according to the final destination or use of the material.

8 Turbidity Monitoring

8.1 During DMMA operations discharging return water into the receiving waters, water samples shall be obtained and analyzed for turbidity. Sampling shall be conducted in accordance with techniques described in the latest edition of "Standard Methods" published by the American Public Health Association (APHA), American Waterworks Association (AWWA), and Water Pollution Control Federation (WPCF), and other current techniques recognized by the scientific community. Samples obtained for turbidity analysis shall be analyzed within 30 minutes of collection. Samples shall be taken with a sampler obtaining samples uncontaminated by water from any other sampling.

8.2 Turbidity Monitoring Equipment

Monitoring required for turbidity shall be measured in Nephelometric Turbidity Units (NTU) using a standard Nephelometer. Global Positioning System (GPS) is also required to record sampling stations. The analyst shall provide a certification, attesting to the accuracy of his testing equipment and procedure.

8.3 Routine Monitoring Locations

- a. Station 1 (Compliance Turbidity): weir overflow.
- b. Station 2 (Background Turbidity): at least 300 meters upcurrent from the point of discharge and outside of any turbidity generated by the project.
- c. Station 3 (Compliance Turbidity): at least 150 meters downcurrent from the point of discharge and in the direction of the densest portion of any visible plume.



8.4 If the sample collected at weir discharge does not exceed 29 ntu, then sampling at Stations 2 or 3 is not required for the sampling event. If the sample collected at weir discharge exceeds 29 ntu, a background turbidity sample shall be collected at Station 2. If the sample collected at weir discharge exceeds 29 ntu over the background sample, a compliance turbidity sample shall be collected at Station 3 (edge of 150 m mixing zone). Additional sampling shall be performed when there may be non-compliance with water quality standards or if required by the dredging permit associated with the current project or if required by other relevant permit documents.

8.5 Frequency

Samples to be analyzed for turbidity shall be taken twice daily at least 4 hours apart at mid-stream/depth.

8.6 Reporting

The monitoring data shall be recorded on summary forms that contain the pertinent information in the following paragraphs.

8.7 Report Contents

- a. Permit number.
- b. Dates of sampling and analysis.
- c. A statement describing the methods used in collection, handling, storage, and quality control methods used in the analysis of the samples.
- d. A map indicating the sampling location and plume configuration, if any.
- e. A map plotting the discharge location relative to the water sample locations. This map can be combined with the map indicating the sampling location.
- f. A statement by the individual responsible for implementation of the sampling program concerning the authenticity, precision, limits of detection, and accuracy of the data.
- g. Results of the analyses.
- h. A description of any factors influencing the disposal area operation or the sampling program.

During dredging projects, reports shall be furnished daily even when no sampling is conducted. When sampling is not conducted, a brief statement shall be given in the report explaining the reason for not conducting the sampling, such as "dredge not working due to mechanical problems" or "no sampling taken due to high winds."

- i. State plane coordinates (x and y) or GPS coordinates (lat/longs) shall be provided for all sampling stations along with the coordinates of the discharge pipe and the distance between the sampling station and discharge pipe for each sampling event to demonstrate compliance with the stated sampling distances.

8.8 Monitoring reports shall also include the following information for each day that samples are taken:

- a. Time of day and date samples were taken.
- b. Depth of water body.
- c. Depth of sample.
- d. Antecedent weather conditions.
- e. Tidal stage and direction of flow.
- f. Discharge location (station location and map).
- g. Water sample location.
- h. Wind direction and velocity.



8.9 Notification

If turbidity exceeds background levels by more than 29 NTU at the edge of the mixing zone, the analyst shall immediately notify all appropriate parties. In addition, the activity causing the exceedance shall immediately be modified to reduce turbidity to acceptable levels as soon as possible. If turbidity has not returned to acceptable levels within 24 hours, discharge shall cease and shall not resume until corrective measures have been taken and turbidity has returned to acceptable levels.



BID DRAWINGS FOR: BUCK ISLAND DREDGED MATERIAL MANAGEMENT AREA SITE IMPROVEMENTS JACKSONVILLE PORT AUTHORITY (JAXPORT) JACKSONVILLE, DUVAL COUNTY, FLORIDA

\\JAX-SRV3\projects\JAXPORT\2015 CIP Contract\10161139_AE-1658 Buck Island Toe Dike\Submittals\90% Submittal\Jax Port_Buck Island Dredge - HDR\6735199447_HDR Jaxport Buck Island_Cover.dwg LAYOUT: 1 SAVED: 7/31/2020 4:34 PM PLOTSTYLETABLE: CIVIL-MASTER.CTB PLOTTED: 7/31/2020 4:36 PM BY: RAYMOND, JUSTIN



SITE LOCATION MAP

DUVAL COUNTY, FLORIDA
SECTION 27, TOWNSHIP 1 SOUTH, RANGE 28 EAST

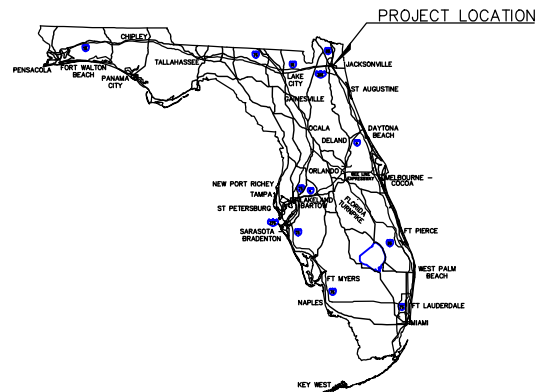

INDEX OF DRAWINGS	
SHEET 1	COVER SHEET
SHEET 2	GENERAL NOTES
SHEET 3	EXISTING CONDITIONS
SHEET 4	PROPOSED SITE TOPOGRAPHY
SHEET 5	GEOTECHNICAL BORING LOCATIONS
SHEET 6	CROSS SECTIONS (1 OF 5)
SHEET 7	CROSS SECTIONS (2 OF 5)
SHEET 8	CROSS SECTIONS (3 OF 5)
SHEET 9	CROSS SECTIONS (4 OF 5)
SHEET 10	CROSS SECTIONS (5 OF 5)
SHEET 11	STEEL SHEET PILE WALL
SHEET 12	REPRESENTATIVE GEOTECHNICAL BORING LOG
SHEET 13	CELL B IMPROVEMENTS AND DRAINAGE PLAN
SHEET 14	CELL B DITCHING AND DRAINING TYPICAL DETAILS
SHEET 15	EROSION CONTROL TYPICAL DETAILS

PREPARED BY:



ENGINEER OF RECORD

I HEREBY CERTIFY THAT I AM REGISTERED PROFESSIONAL ENGINEER IN THE STATE OF FLORIDA PRACTICING WITH HDR ENGINEERING, INC. 76 SOUTH LAURA STREET, SUITE 1600, JACKSONVILLE, FL 32202. A CORPORATION AUTHORIZED TO OPERATE AS BUSINESS PROVIDING ENGINEERING CONSULTING SERVICES BY THE STATE OF FLORIDA DEPARTMENT OF FINANCE AND PROFESSIONAL REGULATIONS. I FURTHER CERTIFY THAT I, OR OTHERS UNDER MY DIRECT SUPERVISION, HAVE PREPARED THE ENGINEERING EVALUATIONS, FINDINGS, OPINIONS, CALCULATIONS, CONCLUSIONS OR TECHNICAL ADVICE HEREBY REPRESENTED IN THIS REPORT.

\\JAX-SRV3\projects\JAXPORT\2015 CIP Contract\10161139_AE-1658 Buck Island Toe Dike\Submittals\90% Submittal\Jax Port Buck Island Dredge - HDR\6735199447_HDR Jaxport Buck Island GSWC_2020.dwg LAYOUT: 3 SAVED: 7/31/2020 4:11 PM PLOTSTYLETABLE: ---- PLOTTED: 7/31/2020 4:21 PM BY: RAYMOND, JUSTIN

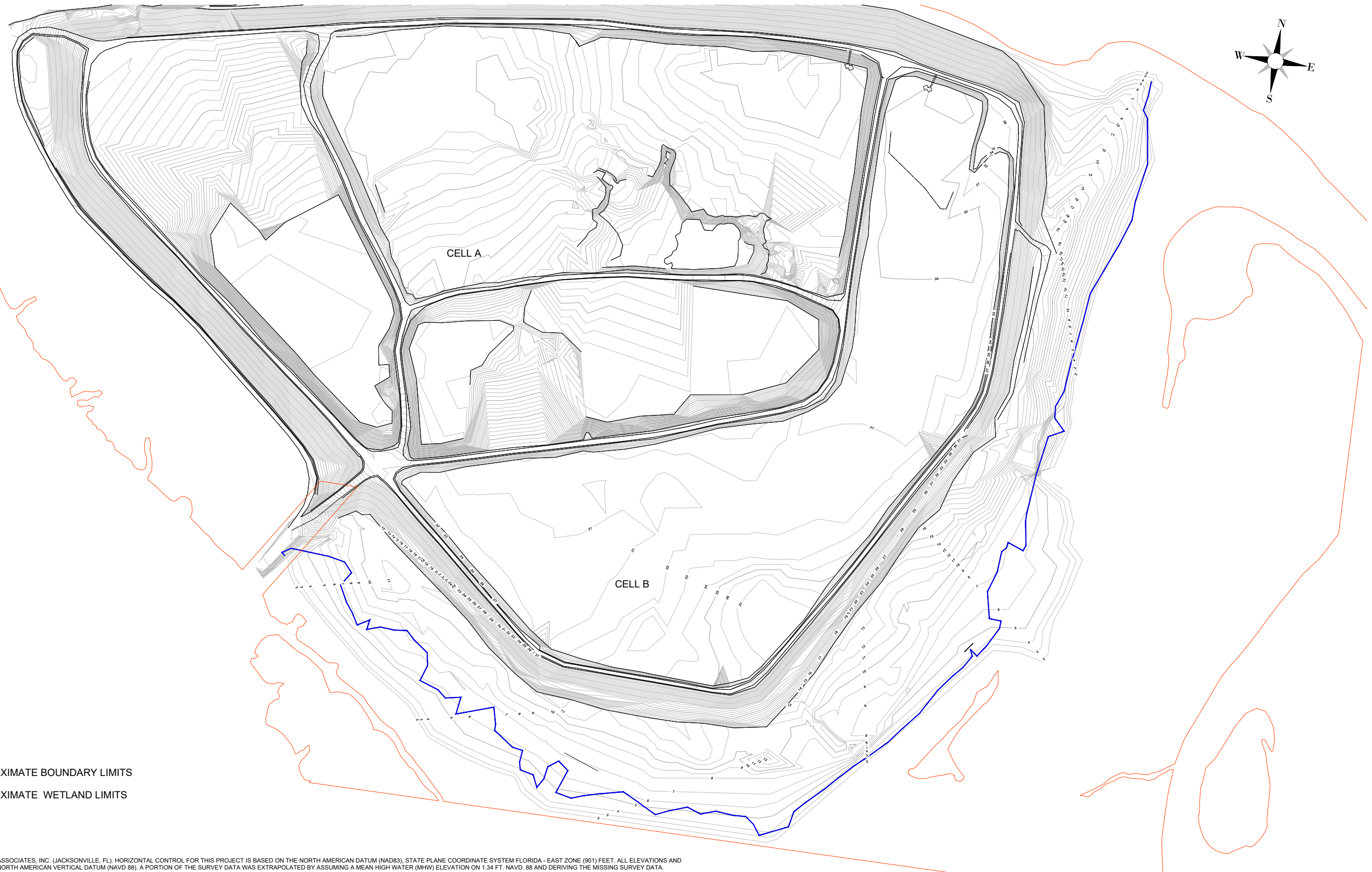

LEGEND

- APPROXIMATE BOUNDARY LIMITS
- APPROXIMATE WETLAND LIMITS

SURVEY DATA PROVIDED BY: B.V. & ASSOCIATES, INC. (JACKSONVILLE, FL). HORIZONTAL CONTROL FOR THIS PROJECT IS BASED ON THE NORTH AMERICAN DATUM (NAD83), STATE PLANE COORDINATE SYSTEM FLORIDA - EAST ZONE (901) FEET. ALL ELEVATIONS AND BENCHMARKS SHOWN ARE ON THE NORTH AMERICAN VERTICAL DATUM (NAVD 88). A PORTION OF THE SURVEY DATA WAS EXTRAPOLATED BY ASSUMING A MEAN HIGH WATER (MHW) ELEVATION ON 1.34 FT. NAVD. 88 AND DERIVING THE MISSING SURVEY DATA.



ISSUE	DATE	DESCRIPTION

PROJECT MANAGER	J.WAGNER
DESIGNED BY	L.DeLEON
CHECKED BY	J.WAGNER
DRAWN BY	J.RAYMOND
PROJECT NUMBER	10161139

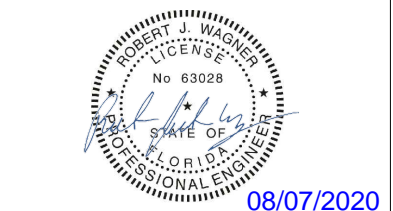

**WORK CONSTRUCTION OF BUCK ISLAND
DREDGE MATERIAL MANAGEMENT AREA SITE IMPROVEMENTS**

**EXISTING CONDITIONS
DUVAL COUNTY, FLORIDA**

0 150' 300' SCALE IN FEET	FILENAME XX SCALE AS_SHOWN
------------------------------	-------------------------------

JPA CONTRACT NUMBER:	C-1737
SHEET	3

\JAX-SRV3\projects\JAXPORT\2015 CIP Contract\10161139_AE-1658 Buck Island Toe Dike\Submittals\90% Submittal\Jax_Port_Buck_Island_Dredge - HDR\6735199447_HDR_Jaxport_Buck_Island_GSWC_2020.dwg LAYOUT:10 SAVED: 7/31/2020 4:11 PM PLOTSTYLETABLE: PLOTTED: 7/31/2020 4:22 PM BY: RAYMOND, JUSTIN

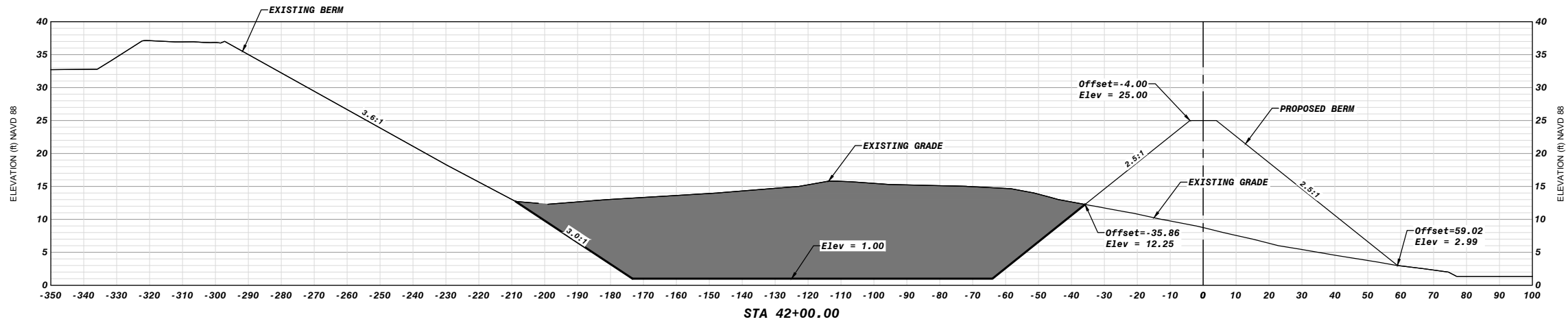
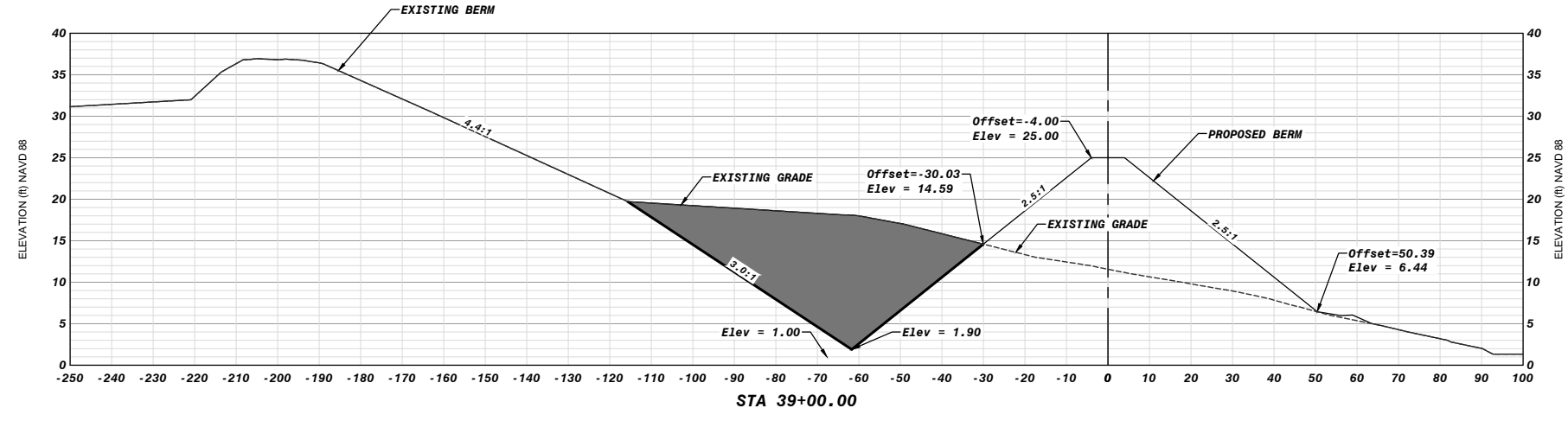

SURVEY DATA PROVIDED BY: B.V. & ASSOCIATES, INC. (JACKSONVILLE, FL). HORIZONTAL CONTROL FOR THIS PROJECT IS BASED ON THE NORTH AMERICAN DATUM (NAD83), STATE PLANE COORDINATE SYSTEM FLORIDA - EAST ZONE (901) FEET. ALL ELEVATIONS AND BENCHMARKS SHOWN ARE ON THE NORTH AMERICAN VERTICAL DATUM (NAVD 88). (*) PROVIDED SURVEY DATA WAS LIMITED. SURFACE EXTENT TO ACTUAL LIMITS BY USING HISTORICAL ELEVATION DATA.



ISSUE	DATE	DESCRIPTION

PROJECT MANAGER	J.WAGNER
DESIGNED BY	L.DeLEON
CHECKED BY	J.WAGNER
DRAWN BY	J.RAYMOND
PROJECT NUMBER	10161139



WORK CONSTRUCTION OF BUCK ISLAND DREDGE MATERIAL MANAGEMENT AREA SITE IMPROVEMENTS		JPA CONTRACT NUMBER: C-1737
CROSS SECTIONS (5 OF 5) DUVAL COUNTY, FLORIDA		
FILENAME	XX	SHEET 10
SCALE	AS_SHOWN	



LOG OF BORING

Project No.: 35-28498
 Boring No.: B11
 Sheet 1 of 3

Project: JAXPORT Buck Island (DMMA) Client: HDR Engineering
 Drill Rig: 101A Driller: M. Letchworth
 Boring Location: See Field Exploration Plan Drill Rod: AWJ Drill Mud: Super Gel-X
 Casing Size: Length of Casing:
 Groundwater Depth: 2 ft. Time: Drilling Date: 4/4/19 Boring Begun: 4/4/19 Boring Completed: 4/4/19

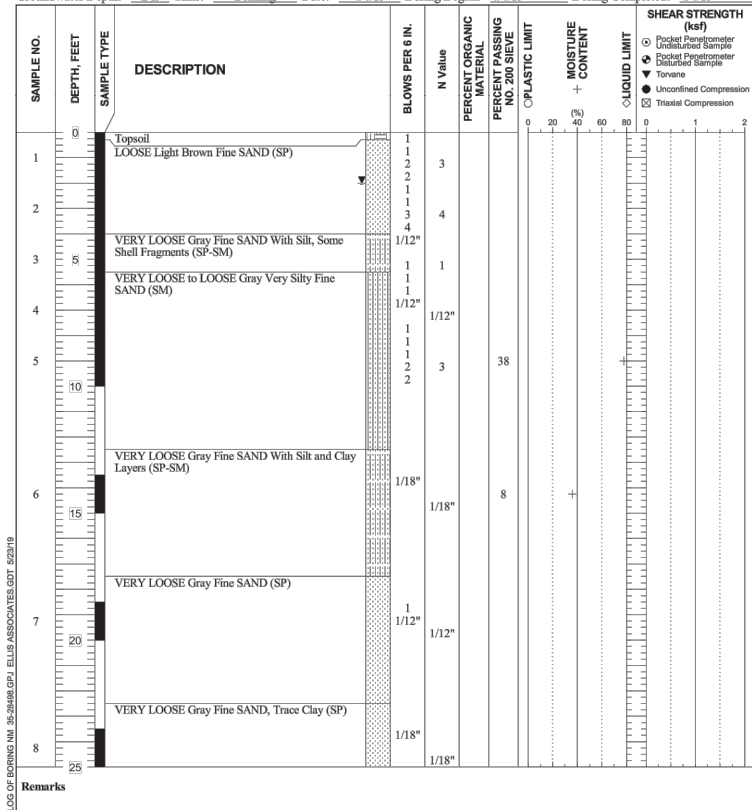

LOG OF BORING

Project No.: 35-28498
 Boring No.: B11
 Sheet 2 of 3

Project: JAXPORT Buck Island (DMMA) Client: HDR Engineering
 Drill Rig: 101A Driller: M. Letchworth
 Boring Location: See Field Exploration Plan Drill Rod: AWJ Drill Mud: Super Gel-X
 Casing Size: Length of Casing:
 Groundwater Depth: 2 ft. Time: Drilling Date: 4/4/19 Boring Begun: 4/4/19 Boring Completed: 4/4/19

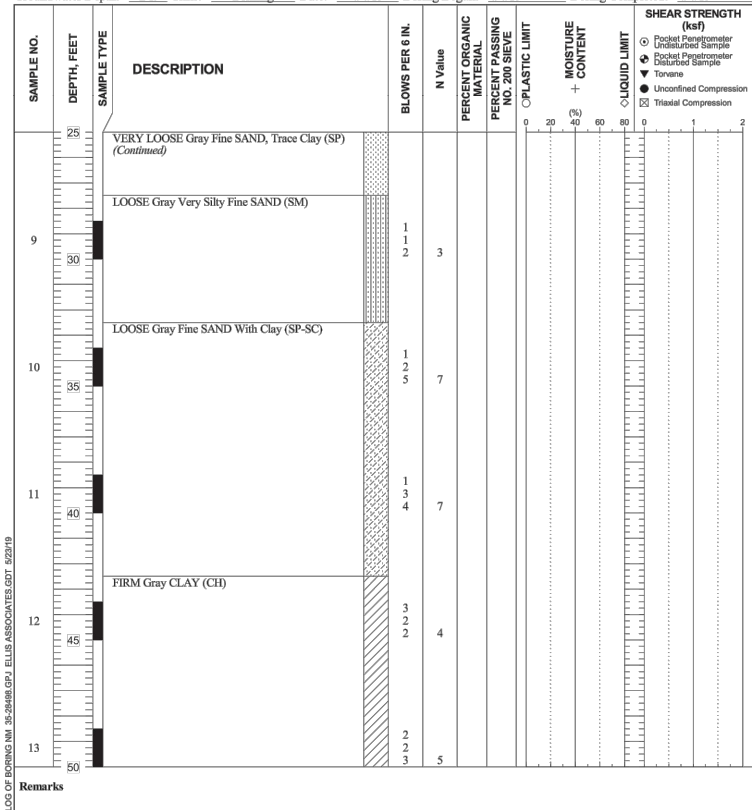

LOG OF BORING

Project No.: 35-28498
 Boring No.: B11
 Sheet 3 of 3

Project: JAXPORT Buck Island (DMMA) Client: HDR Engineering
 Drill Rig: 101A Driller: M. Letchworth
 Boring Location: See Field Exploration Plan Drill Rod: AWJ Drill Mud: Super Gel-X
 Casing Size: Length of Casing:
 Groundwater Depth: 2 ft. Time: Drilling Date: 4/4/19 Boring Begun: 4/4/19 Boring Completed: 4/4/19

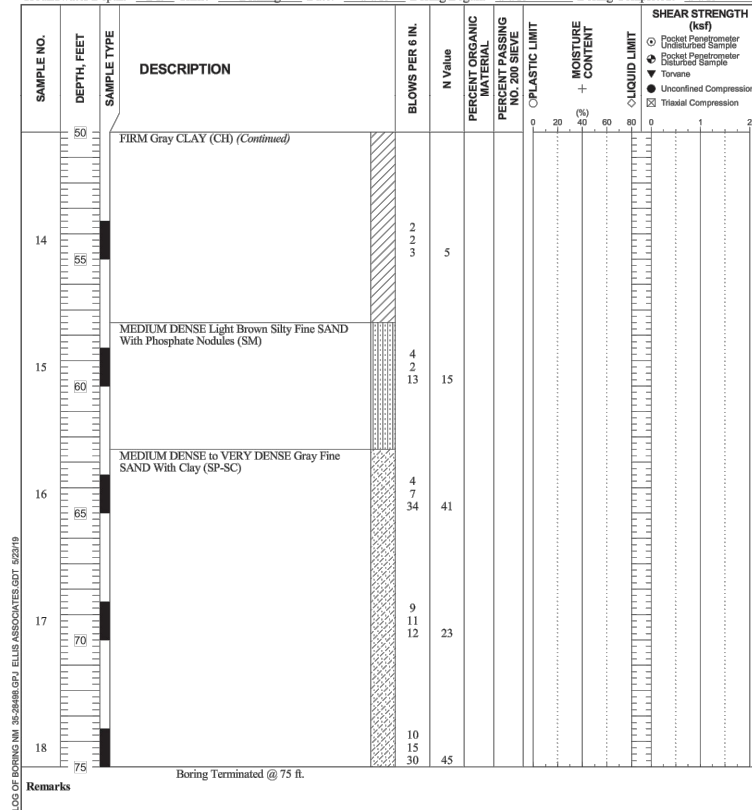

FOR ADDITIONAL BORING LOGS REFER TO REPORT ISSUED BY ECS FLORIDA, LLC TITLE "GEOTECHNICAL ENGINEERING REPORT, JAXPORT BUCK ISLAND DMMA" DATED APRIL 29, 2020.



ISSUE	DATE	DESCRIPTION

PROJECT MANAGER	J.WAGNER
DESIGNED BY	L.DeLEON
CHECKED BY	J.WAGNER
DRAWN BY	J.RAYMOND
PROJECT NUMBER	10161139



WORK CONSTRUCTION OF BUCK ISLAND DREDGE MATERIAL MANAGEMENT AREA SITE IMPROVEMENTS REPRESENTATIVE GEOTECHNICAL BORING LOG DUVAL COUNTY, FLORIDA		JPA CONTRACT NUMBER: C-1737
FILENAME	XX	SHEET
SCALE	AS_SHOWN	12

\\JAX-SRV\3\projects\JAXPORT\2015 CIP Contract\10161139_AE-1668 Buck Island Toe Dike\Submittals\90% Submittal\Jax Port_Buck Island Dredge - HDR\673519947_HDR-Jaxport-Buck Island_Pres.dwg LAYOUT: 13 SAVED: 7/31/2020 11:05 AM PLOTSTYLETABLE: — PLOTTED: 7/31/2020 4:19 PM BY: RAYMOND, JUSTIN



LEGEND

- INTERNAL PERIMETER
- SUMP
- REMOVED FOR TOE DIKE MATERIAL

DIMENSIONS		
	LENGTH	AREA (ft. ²)
INTERNAL PERIMETER	5873	1052153

- NOTES:**
1. CONTRACTOR TO DETERMINE CONFIGURATION OF DITCHES WITHIN CELL B TO ACHIEVE MAXIMUM DRAINAGE.
 2. PAYMENT FOR DITCHING AND DRAINING IS PERFORMANCE BASED.

BUCK ISLAND

1 & 2
14



ISSUE	DATE	DESCRIPTION

PROJECT MANAGER	J.WAGNER
DESIGNED BY	L.DeLEON
CHECKED BY	J.WAGNER
DRAWN BY	J.RAYMOND
PROJECT NUMBER	10161139



WORK CONSTRUCTION OF BUCK ISLAND DREDGE MATERIAL MANAGEMENT AREA SITE IMPROVEMENTS CELL B IMPROVEMENTS AND DRAINAGE PLAN DUVAL COUNTY, FLORIDA	
FILENAME	XX
SCALE	AS_SHOWN

JPA CONTRACT NUMBER:	C-1737
SHEET	13

\JAX-SRV\3\projects\JAXPORT\2015 CIP Contract\10161139_AE-1668 Buck Island Toe Dike\Submittals\90% Submittal\Jax_Port_Buck Island Dredge - HDR\673519947_HDR-Jaxport-Buck Island_Pres.dwg LAYOUT: 14 SAVED: 7/31/2020 11:05 AM PLOTSTYLETABLE: — PLOTTED: 7/31/2020 4:19 PM BY: RAYMOND, JUSTIN

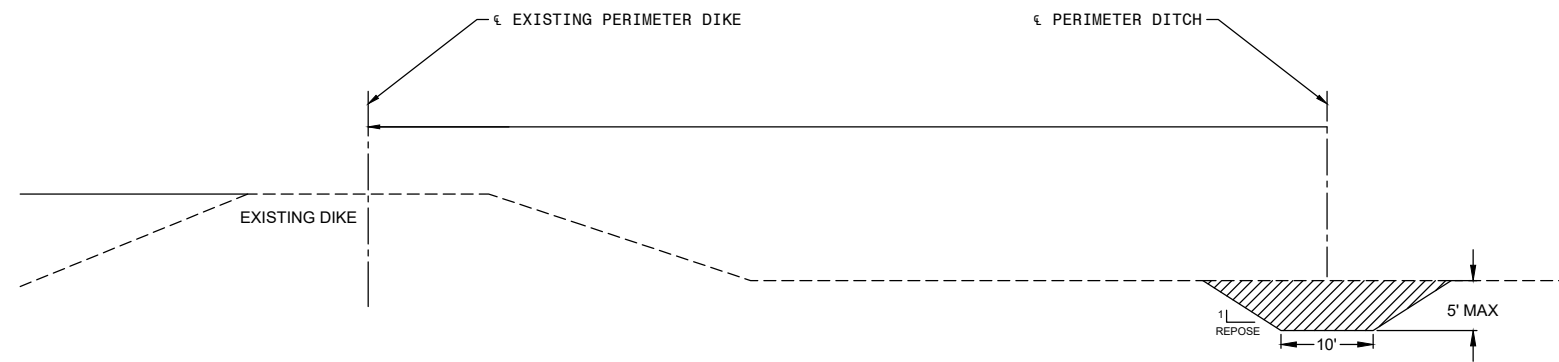

1 TYPICAL PERIMETER CROSS-SECTION
Not To Scale

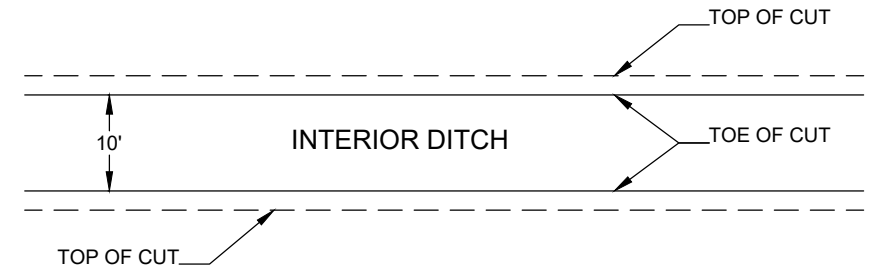

2 PERIMETER DITCH PLAN
Not To Scale

NOTES:
1. CONTRACTOR TO DETERMINE CONFIGURATION OF DITCHES WITHIN CELL B TO ACHIEVE MAXIMUM DRAINAGE.



HDR Engineering, Inc.
76 S Laura St
Suite 1600
Jacksonville, Florida 32202
Certificate of Authorization No. 4213

ISSUE	DATE	DESCRIPTION

PROJECT MANAGER	J.WAGNER
DESIGNED BY	L.DeLEON
CHECKED BY	J.WAGNER
DRAWN BY	J.RAYMOND
PROJECT NUMBER	10161139

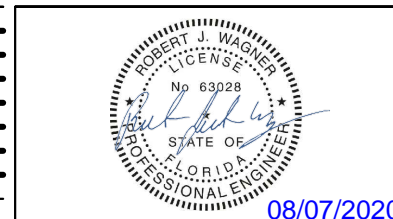

WORK CONSTRUCTION OF BUCK ISLAND DREDGE MATERIAL MANAGEMENT AREA SITE IMPROVEMENTS CELL B DITCHING AND DRAINING TYPICAL DETAILS DUVAL COUNTY, FLORIDA		JPA CONTRACT NUMBER: C-1737
FILENAME	XX	SHEET
SCALE	AS_SHOWN	14

\JAX-SRV\3\projects\JAXPORT\2015 CIP Contract\10161139_AE-1668 Buck Island Toe Dike\Submittals\90% Submittal\Jax_Port_Buck Island Dredge - HDR\673519947_HDR_Export Buck Island Pres.dwg LAYOUT: 15 SAVED: 7/31/2020 11:05 AM PLOTSTYLETABLE: — PLOTTED: 7/31/2020 4:19 PM BY: RAYMOND, JUSTIN

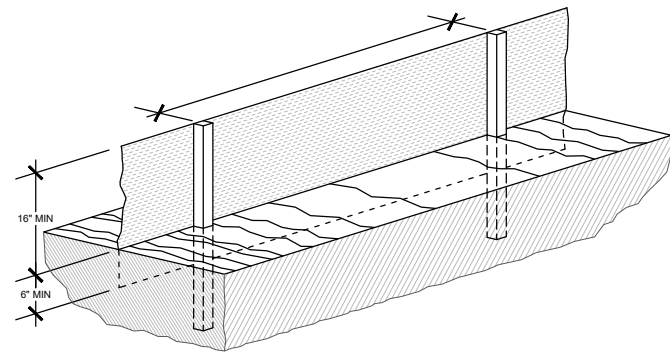

1 **TYPICAL SILT FENCE DETAIL**
Not To Scale

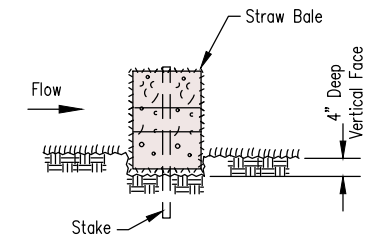

BEDDING DETAIL

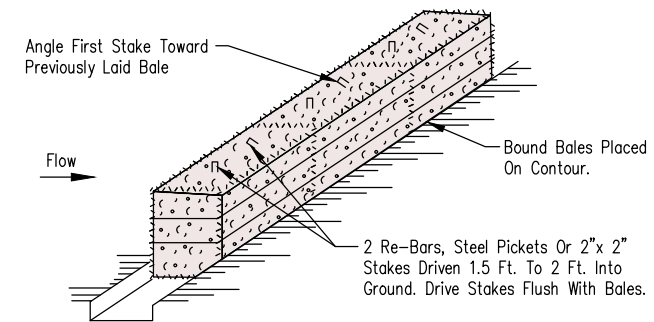

2 **TYPICAL HAY/STAW BALE DETAIL**
Not To Scale



HDR Engineering, Inc.
 76 S Laura St
 Suite 1600
 Jacksonville, Florida 32202
 Certificate of Authorization No. 4213

ISSUE	DATE	DESCRIPTION

PROJECT MANAGER	J.WAGNER
DESIGNED BY	L.DeLEON
CHECKED BY	J.WAGNER
DRAWN BY	J.RAYMOND
PROJECT NUMBER	10161139

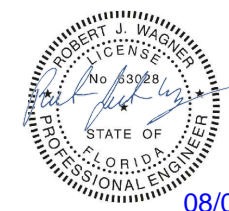

08/07/2020



WORK CONSTRUCTION OF BUCK ISLAND DREDGE MATERIAL MANAGEMENT AREA SITE IMPROVEMENTS		JPA CONTRACT NUMBER: C-1737
EROSION CONTROL TYPICAL DETAILS DUVAL COUNTY, FLORIDA		
FILENAME	XX	SHEET 15
SCALE	AS_SHOWN	

APPENDIX C

Department of the Army Permit

THIS PAGE INTENTIONALLY LEFT BLANK



DEPARTMENT OF THE ARMY
CORPS OF ENGINEERS, JACKSONVILLE DISTRICT
701 SAN MARCO BOULEVARD
JACKSONVILLE, FLORIDA 32207-8175

May 10, 2023

Regulatory Division
North Permits Branch
Jacksonville Permits Section
SAJ-1994-03114 (SP-BJC)

Jacksonville Port Authority
Attn: Mr. James Bennett
2831 Tallyrand Avenue
Jacksonville, Florida 32206
Sent via email: James.Bennett@jaxport.com

Dear Mr. Bennett:

The U.S. Army Corps of Engineers (Corps) is pleased to enclose the Department of the Army permit, which should be available at the construction site. Work may begin immediately but the Corps must be notified of:

- a. The date of commencement of the work,
- b. The dates of work suspensions and resumptions of work, if suspended over a week, and
- c. The date of final completion.

This information should be emailed to the Enforcement Section of the Regulatory Division of the Jacksonville District at saj-rd-enforcement@usace.army.mil. The Enforcement Section is also responsible for inspections to determine whether Permittees have strictly adhered to permit conditions.

Should any other agency require and/or approve changes to the work authorized or obligated by this permit, it is the responsibility of the Permittee to submit a modification request to the Jacksonville Permits Section. The Corps will evaluate the request and determine whether it is appropriate to modify the terms and conditions of the permit. The Permittee must obtain written approval of the requested modifications from the Corps prior to initiation of those changes.

IT IS NOT LAWFUL TO DEVIATE FROM THE APPROVED PLANS ENCLOSED.

Sincerely,

For: Shawn H. Zinszer
Chief, Regulatory Division

Enclosures

cc:
Taylor Engineering, Inc., Attn: Mr. Noah Adams – Nadams@taylorengeering.com.

DEPARTMENT OF THE ARMY PERMIT

Permittee: JACKSONVILLE PORT AUTHORITY
ATTN: MR. JAMES BENNETT
2831 TALLYRAND AVENUE
JACKSONVILLE, FLORIDA 32206

Permit No: SAJ-1994-03114 (SP-BJC)

Issuing Office: U.S. Army Engineer District, Jacksonville

NOTE: The term "you" and its derivatives, as used in this permit, means the permittee or any future transferee. The term "this office" refers to the appropriate district or division office of the U.S. Army Corps of Engineers (Corps) having jurisdiction over the permitted activity or the appropriate official of that office acting under the authority of the commanding officer.

You are authorized to perform work in accordance with the terms and conditions specified below.

Project Description: The Permittee is authorized to modify and expand an existing berth to accommodate larger vessels. The project includes the 8,896 square-foot landward expansion of a section of an existing pier, adding an additional 954 square-foot breasting dolphin, and adding an additional 970 square foot mooring dolphin with catwalk to the existing dolphin, as well as necessary repairs to the underdeck concrete spall, piles (jacket installation), bollards and fenders of the existing structure. In addition, the Permittee would use hydraulic and mechanical methods to expand the dredge template by 66,888 square feet to include removal of additional 17,650 cubic yards of the sediments to a depth of 38 feet below the mean low water line (with 2 feet of allowable overdredge) from 1.536 acres of the aquatic substrate. The dredge material would be disposed of at an approved JaxPort Upland Disposal Facility. The work described above is to be completed in accordance with the pages of drawings affixed at the end of this permit instrument.

Project Location: The project site is located at 500 Williams Mills Street in Sections 24 and 25, Township 1 South, Range 27 East, Jacksonville, Duval County, Florida. The central coordinates are Latitude 30.396396°, Longitude -81.549279°. The project would affect waters of the United States, a traditionally navigable waterway, known as the the St. Johns River.

Directions to site: From Interstate-95 take Exit 362A. Proceed onto Interstate-295 and take Exit 41. Take a left (east) on Heckscher Drive. Proceed until the intersection of Blunt Island Boulevard and turn right. Proceed until the intersection of William Mills Street and turn right. The project is at the end of the roadway.

PERMIT NUMBER: SAJ-1994-03114
PERMITTEE: JaxPort Authority
PAGE 2 of 11

Approximate Central Coordinates: Latitude: 30.396396°
Longitude: -81.549279°

Permit Conditions

General Conditions:

1. The time limit for completing the work authorized ends on **May 10, 2028**. If you find that you need more time to complete the authorized activity, submit your request for a time extension to this office for consideration at least one month before the above date is reached.
2. You must maintain the activity authorized by this permit in good condition and in conformance with the terms and conditions of this permit. You are not relieved of this requirement if you abandon the permitted activity, although you may make a good faith transfer to a third party in compliance with General Condition 4 below. Should you wish to cease to maintain the authorized activity, or should you desire to abandon it without a good faith transfer, you must obtain a modification of this permit from this office, which may require restoration of the area.
3. If you discover any previously unknown historic or archeological remains while accomplishing the activity authorized by this permit, you must immediately notify this office of what you have found. We will initiate the Federal and State coordination required to determine if the remains warrant a recovery effort or if the site is eligible for listing in the National Register of Historic Places.
4. If you sell the property associated with this permit, you must obtain the signature and the mailing address of the new owner in the space provided and forward a copy of the permit to this office to validate the transfer of this authorization.
5. If a conditioned water quality certification has been issued for your project, you must comply with the conditions specified in the certification as special conditions to this permit. For your convenience, a copy of the certification is attached if it contains such conditions.
6. You must allow representatives from this office to inspect the authorized activity at any time deemed necessary to ensure that it is being or has been accomplished in accordance with the terms and conditions of your permit.

Special Conditions:

PERMIT NUMBER: SAJ-1994-03114
PERMITTEE: JaxPort Authority
PAGE 3 of 11

1. Reporting Address: The Permittee shall submit all reports, notifications, documentation, and correspondence required by the general and special conditions of this permit to either (not both) of the following addresses:

- a. For electronic mail (preferred): SAJ-RD-Enforcement@usace.army.mil (not to exceed 15 MB).
- b. For standard mail: U.S. Army Corps of Engineers, Regulatory Division, Enforcement Section, P.O. Box 4970, Jacksonville, FL 32232-0019.

The Permittee shall reference this permit number, SAJ-1994-03114 (SP –BJC), on all submittals.

2. Commencement Notification: Within 10 days from the date of initiating the work authorized by this permit, the Permittee shall submit a completed “Commencement Notification” form.

3. Posting of Permit: The Permittee shall have available and maintain for review a copy of this permit and approved plans at the construction site.

4. Cultural Resources/Historic Properties:

- a. No structure or work shall adversely affect, impact, or disturb properties listed in the *National Register of Historic Places* (NRHP), or those eligible for inclusion in the NRHP.
- b. If, during permitted activities, items that may have historic or archaeological origin are observed the Permittee shall immediately cease all activities adjacent to the discovery that may result in the destruction of these resources and shall prevent his/her employees from further removing, or otherwise damaging, such resources. The applicant shall notify both the Florida Department of State, Division of Historical Resources, Compliance Review Section at (850)-245-6333 and the Corps, of the observations within the same business day (8 hours). Examples of submerged historical, archaeological or cultural resources include shipwrecks, shipwreck debris fields (such as steam engine parts, or wood planks and beams), anchors, ballast rock, concreted iron objects, concentrations of coal, prehistoric watercraft (such as log "dugouts"), and other evidence of human activity. The materials may be deeply buried in sediment, resting in shallow sediments or above them, or protruding into water. The Corps shall coordinate with the Florida State Historic Preservation Officer (SHPO) to assess

the significance of the discovery and devise appropriate actions. Project activities shall not resume without verbal and/or written authorization from the Corps.

- c. Additional cultural resources assessments may be required of the permit area in the case of unanticipated discoveries as referenced in accordance with the above Special Condition and, if deemed necessary by the SHPO or Corps, in accordance with 36 CFR 800 or 33 CFR 325, Appendix C (5). Based on the circumstances of the discovery, equity to all parties, and considerations of the public interest, the Corps may modify, suspend, or revoke the permit in accordance with 33 CFR Part 325.7. Such activity shall not resume on non-federal lands without written authorization from the SHPO for finds under his or her jurisdiction, and from the Corps.
- d. In the unlikely event that unmarked human remains are identified on non-federal lands; they will be treated in accordance with Section 872.05 Florida Statutes. All work and ground disturbing activities within a 100-meter diameter of the unmarked human remains shall immediately cease and the Permittee shall immediately notify the medical examiner, Corps, and State Archaeologist within the same business day (8-hours). The Corps shall then notify the appropriate SHPO. Based on the circumstances of the discovery, equity to all parties, and considerations of the public interest, the Corps may modify, suspend, or revoke the permit in accordance with 33 CFR Part 325.7. Such activity shall not resume without written authorization from the SHPO and from the Corps.

5. Assurance of Navigation and Maintenance: The Permittee understands and agrees that, if future operations by the United States require the removal, relocation, or other alteration, of the structures or work herein authorized, or if in the opinion of the Secretary of the Army or his authorized representative, said structure or work shall cause unreasonable obstruction to the free navigation of the navigable waters, the Permittee will be required, upon due notice from the U.S. Army Corps of Engineers, to remove, relocate, or alter the structural work or obstructions caused thereby, without expense to the United States. No claim shall be made against the United States on account of any such removal or alteration.

6. Individual Section 408 Approval: It has been determined that the activities authorized do not impair the usefulness of the Blount Island Channel Project and are not injurious to the public interest. The Permittee shall adhere to the conditions and limitations referenced in the Section 408 approval memo of this permit. All documentation required in the Section 408 approval memo, including a certification that the work was completed in accordance with the approved plans and specifications, GPS

readings for the limits of the work performed, as-built drawings, and the date the work started and was completed, shall be submitted either electronically by email at ENPermits.CESAJ@usace.army.mil or by standard mail at Post Office Box 4970, Jacksonville Florida 32232-0019. For all questions related to the Section 408 approval, contact the Corps, Jacksonville Engineering Division by telephone at 904-232-1604. Engineering Division is the appropriate authority to determine compliance with the terms and conditions of Section 408 approval.

7. Manatee Conditions:

- a. The Permittee shall comply with the “Standard Manatee Conditions for In-Water Work – 2011”. The most recent version of the Manatee Conditions must be utilized.
- b. Fenders with at least 4-feet of standoff at maximum compression will be required on all piers where ships may be moored, and between multiple ships/barges if moored together during construction or operation.
- c. The Permittee shall also implement the Jaxport Manatee Awareness, Protection, and Reporting Plan attached to this permit instrument.

8. Protected Species Construction Conditions: The Permittee shall comply with National Marine Fisheries Service’s “Protected Species Construction Conditions, NOAA Fisheries Southeast Regional Office” dated May 2021, as well as the Conservation Measures and BMPs provided by the applicant to the Corps which was the basis for the concurrence provided by the National Marine Fisheries Service in their letter dated November 8, 2022.

9. Dredged Material Disposal: The Permittee shall place all dredged material in a self-contained, upland disposal site. The Permittee shall maintain the upland disposal site to prevent the discharge of dredged material into waters of the United States.

10. Daylight Hours: All work must occur during daylight hours.

11. As-Built Certification with X-Y-Z Coordinates: Within 60 days of completion of the authorized work or at the expiration of the construction window of this permit, whichever occurs first, the Permittee shall submit as-built drawings of the authorized work and a completed version of the enclosed “As-Built Certification by Professional Engineer or Surveyor” form to the Corps. The drawings shall be signed and sealed by a registered professional engineer or a professional land surveyor confirming the actual location of all authorized work/structures with respect to the Federal channel and/or within the Federal easement and include the following:

- a. A plan view drawing of the location of the authorized work footprint (as shown on the permit drawings) with an overlay of the work as constructed in the same scale as the attached permit drawings (8½-inch by 11-inch). The drawings shall include the X & Y State Plane coordination points of the most waterward point of the structure, as well as the Z-azimuth for subaqueous utilities. The drawings shall include the dimensions of the structure, depth of water (at mean low water) at the waterward end of the structure, and the distance from the waterward end of the structure to the near design edge of the Federal channel.
- b. List of any deviations between the work authorized by this permit and the work as constructed. In the event the completed work deviates, in any manner, from the authorized work, describe on the As-Built Certification Form the deviations between the work authorized by this permit and the work as constructed. Clearly indicate on the as-built drawings any deviations that have been listed. Please note the depiction and/or description of any deviations on the drawings and/or As-Built Certification Form does not constitute approval of any deviations by the Corps.
- c. The Department of the Army Permit number.
- d. Within 60 days of completion of the work authorized by this permit, the Permittee shall provide a courtesy copy of the signed and sealed As-Built drawings to the Corps, Engineering Division. Submittals shall be sent either electronically by email at ENPermits.CESAJ@usace.army.mil or by standard mail at Post Office Box 4970, Jacksonville Florida 32232-0019.

Further Information:

1. Congressional Authorities: You have been authorized to undertake the activity described above pursuant to:

Section 10 of the Rivers and Harbors Act of 1899 (33 U.S.C. 403)

Section 404 of the Clean Water Act (33 U.S.C. 1344)

Section 103 of the Marine Protection, Research and Sanctuaries Act of 1972 (33 U.S.C. 1413)

Section 14 of the Rivers and Harbors Act of 1899 (33 U.S.C. 408)

2. Limits of this authorization.

a. This permit does not obviate the need to obtain other Federal, State, or local authorizations required by law.

b. This permit does not grant any property rights or exclusive privileges.

c. This permit does not authorize any injury to the property or rights of others.

d. This permit does not authorize interference with any existing or proposed Federal projects.

3. Limits of Federal Liability. In issuing this permit, the Federal Government does not assume any liability for the following:

a. Damages to the permitted project or uses thereof as a result of other permitted or unpermitted activities or from natural causes.

b. Damages to the permitted project or uses thereof as a result of current or future activities undertaken by or on behalf of the United States in the public interest.

c. Damages to persons, property, or to other permitted or unpermitted activities or structures caused by the activity authorized by this permit.

d. Design or construction deficiencies associated with the permitted work.

e. Damage claims associated with any future modification, suspension, or revocation of this permit.

4. Reliance on Applicant's Data: The determination of this office that issuance of this permit is not contrary to the public interest was made in reliance on the information you provided.

5. Reevaluation of Permit Decision: This office may reevaluate its decision on this permit at any time the circumstances warrant. Circumstances that could require a reevaluation include, but are not limited to, the following:

a. You fail to comply with the terms and conditions of this permit.

b. The information provided by you in support of your permit application proves to have been false, incomplete, or inaccurate (see 4 above).

PERMIT NUMBER: SAJ-1994-03114
PERMITTEE: JaxPort Authority
PAGE 8 of 11

c. Significant new information surfaces which this office did not consider in reaching the original public interest decision.

Such a reevaluation may result in a determination that it is appropriate to use the suspension, modification, and revocation procedures contained in 33 CFR 325.7 or enforcement procedures such as those contained in 33 CFR 326.4 and 326.5. The referenced enforcement procedures provide for the issuance of an administrative order requiring you comply with the terms and conditions of your permit and for the initiation of legal action where appropriate. You will be required to pay for any corrective measures ordered by this office, and if you fail to comply with such directive, this office may in certain situations (such as those specified in 33 CFR 209.170) accomplish the corrective measures by contract or otherwise and bill you for the cost.

6. Extensions: General Condition 1 establishes a time limit for the completion of the activity authorized by this permit. Unless there are circumstances requiring either a prompt completion of the authorized activity or a reevaluation of the public interest decision, the Corps will normally give favorable consideration to a request for an extension of this time limit.

PERMIT NUMBER: SAJ-1994-03114
PERMITTEE: JaxPort Authority
PAGE 9 of 11

Your signature below, as permittee, indicates that you accept and agree to comply with the terms and conditions of this permit.

Kelsey Cox
(PERMITTEE)

5/9/2023
(DATE)

Kelsey Cox
(PERMITTEE NAME-PRINTED)

This permit becomes effective when the Federal official, designated to act for the Secretary of the Army, has signed below.

for: JAMES L. BOOTH
Colonel, U.S. Army
District Commander

Date: _____

PERMIT NUMBER: SAJ-1994-03114
PERMITTEE: JaxPort Authority
PAGE 10 of 11

When the structures or work authorized by this permit are still in existence at the time the property is transferred, the terms and conditions of this permit will continue to be binding on the new owner(s) of the property. To validate the transfer of this permit and the associated liabilities associated with compliance with its terms and conditions, have the transferee sign and date below.

(TRANSFEREE-SIGNATURE)

(DATE)

(NAME-PRINTED)

(ADDRESS)

(CITY, STATE, AND ZIP CODE)

PERMIT NUMBER: SAJ-1994-03114
PERMITTEE: JaxPort Authority
PAGE 11 of 11

***Attachments to Department of the Army
Permit Number SAJ-1994-03114***

1. PERMIT DRAWINGS: 9 pages
2. WATER QUALITY CERTIFICATION: Specific Conditions of the water quality permit/certification in accordance with General Condition number 5 on page 2 of this DA permit. 45 pages.
3. MANATEE CONDITIONS: 2 pages, *Standard Manatee Conditions for In-Water Work – 2011*.
4. PROTECTED SPECIES CONSTRUCTION CONDITIONS: 2 pages
5. 408 APPROVAL LETTER AND APPENDIX K: 4 pages
6. COMMENCEMENT NOTIFICATION: 1 page
7. AS-BUILT CERTIFICATION FORM: 2 pages

BLOUNT ISLAND MARINE TERMINAL -- BERTH 22 PIER EXPANSION AND NEW DOLPHINS

DUVAL COUNTY, FLORIDA

DRAWING INDEX

- FIG 1 TITLE SHEET
- FIG 2 PROJECT OVERVIEW
- FIG 3 EXISTING CONDITIONS
- FIG 4 PIER EXPANSION PLAN AND CROSS-SECTION
- FIG 5 MOORING DOLPHIN PLAN AND ELEVATION
- FIG 6 BREASTING DOLPHIN PLAN AND ELEVATION
- FIG 7 AUTHORIZED DREDGING TEMPLATE OVERVIEW
- FIG 8 DREDGING PLAN
- FIG 9 TYPICAL CROSS-SECTION

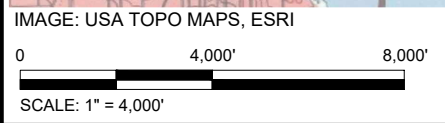

THIS ITEM HAS BEEN DIGITALLY SIGNED AND SEALED BY KEITH A. KNIGHT P.E.# 58084 ON THE DATE ADJACENT TO THE SEAL.
PRINTED COPIES OF THIS DOCUMENT ARE NOT CONSIDERED SIGNED AND SEALED AND THE SIGNATURE MUST BE VERIFIED ON ANY ELECTRONIC COPIES.

TAYLOR ENGINEERING INC.
10199 SOUTHSIDE BLVD SUITE 310
JACKSONVILLE, FLORIDA 32256
REGISTRY # 4815

FIGURE 1
TITLE SHEET
BLOUNT ISLAND MARINE TERMINAL -- BERTH 22 PIER EXPANSION AND NEW DOLPHINS
DUVAL COUNTY, FLORIDA

PROJECT	C2021-051
DRAWN BY	AF
SHEET	1 of 9
DATE	MAR 2022

SEAL

DRAFT

KEITH A. KNIGHT P.E.# 58084 DATE

ANTON.FLEWELLING.X:\S\PROJECTS\C2021-051_BERTH22\PERMIT\FEDERAL\C2021-051-P-TITLE.DWG 3/4/2022 3:56:00 PM

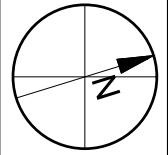

CENTERLINE OF FEDERAL CHANNEL, CUT G

EAST LIMIT OF FEDERAL CHANNEL, CUT G

PROPOSED FENDER REPLACEMENT (TYP)

HOEGH SHANGHAI VEHICLE CARRIER

BERTH 22

PROPOSED PIER EXPANSION (8,896 SQ. FT.)
SEE FIGURE 4

PROPOSED BREASTING DOLPHIN AND ACCESS WALKWAY (954 SQ. FT.)
SEE FIGURE 6

PROPOSED AUTHORIZED DREDGE TEMPLATE EXPANSION (66,888 SQ. FT.)
SEE FIGURE 8

PROPOSED MOORING DOLPHIN AND ACCESS WALKWAY (970 SQ. FT.)
SEE FIGURE 5

AERIAL: GOOGLE EARTH, 2019

0 200' 400'

SCALE: 1" = 200'

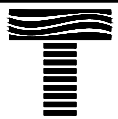

TAYLOR ENGINEERING INC.

10199 SOUTHSIDE BLVD SUITE 310
JACKSONVILLE, FLORIDA 32256
REGISTRY # 4815

FIGURE 2
PROJECT OVERVIEW
BLOUNT ISLAND MARINE TERMINAL -- BERTH 22 PIER EXPANSION AND NEW DOLPHINS
DUVAL COUNTY, FLORIDA

PROJECT	C2021-051
DRAWN BY	AF
SHEET	2 of 9
DATE	MAR 2022

ANTON FLEWELLING X:\SIP\PROJECTS\C2021-051_BERTH22\PERMIT\FEDERAL\C2021-051-P-PROJECT OVERVIEW.DWG 3/4/2022 3:47:37 PM

PRELIMINARY DRAWINGS: THESE DRAWINGS ARE NOT IN FINAL FORM, BUT ARE BEING TRANSMITTED FOR AGENCY REVIEW.

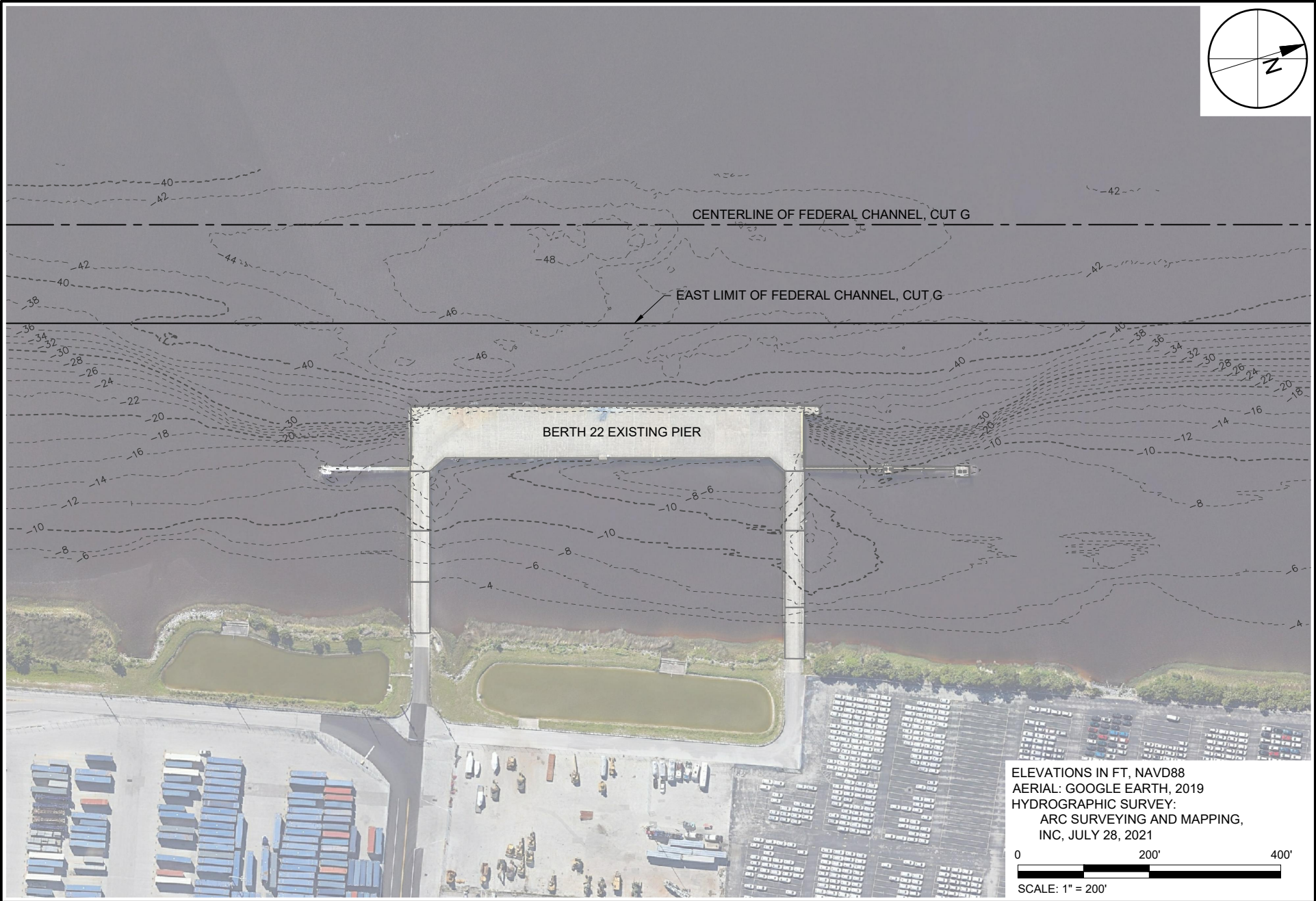
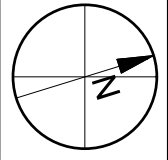

ELEVATIONS IN FT., NAVD88
 AERIAL: GOOGLE EARTH, 2019
 HYDROGRAPHIC SURVEY:
 ARC SURVEYING AND MAPPING,
 INC, JULY 28, 2021

0 200' 400'

SCALE: 1" = 200'

ANTON FLEWELING X:\SIP\PROJECTS\C2021-051_BERTH22\PERMIT\FEDERAL\C2021-051-P-EXISTING CONDITIONS.DWG 3/4/2022 3:48:08 PM

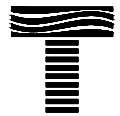

TAYLOR ENGINEERING INC.
 10199 SOUTHSIDE BLVD SUITE 310
 JACKSONVILLE, FLORIDA 32256
 REGISTRY # 4815

FIGURE 3
 EXISTING CONDITIONS
 BLOUNT ISLAND MARINE TERMINAL -- BERTH 22 PIER EXPANSION AND NEW DOLPHINS
 DUVAL COUNTY, FLORIDA

PROJECT	C2021-051
DRAWN BY	AF
SHEET	3 of 9
DATE	MAR 2022

ANTON FLEWELLING X:\S\PROJECTS\C2021-051_BERTH22\PERMIT\FEDERAL\C2021-051-P-SITE PLANS.DWG 3/4/2022 3:46:55 PM

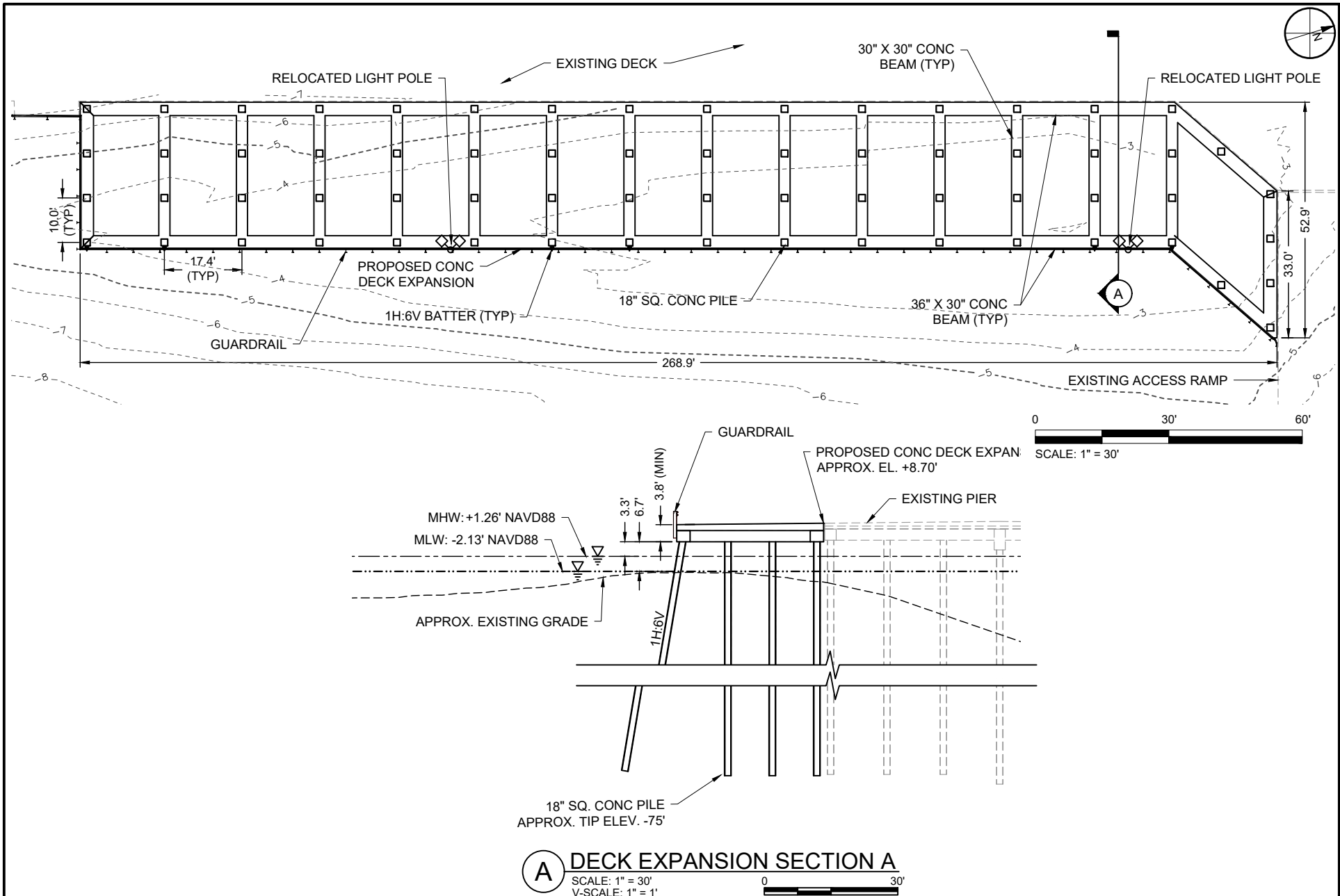

ELEVATIONS IN FT, NAVD88

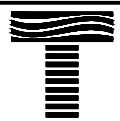

TAYLOR ENGINEERING INC.
 10199 SOUTHSIDE BLVD SUITE 310
 JACKSONVILLE, FLORIDA 32256
 REGISTRY # 4815

FIGURE 4
PIER EXPANSION PLAN AND CROSS-SECTION
BLOUNT ISLAND MARINE TERMINAL -- BERTH 22 PIER EXPANSION AND NEW DOLPHINS
DUVAL COUNTY, FLORIDA

PROJECT	C2021-051
DRAWN BY	AF
SHEET	4 of 9
DATE	MAR 2022

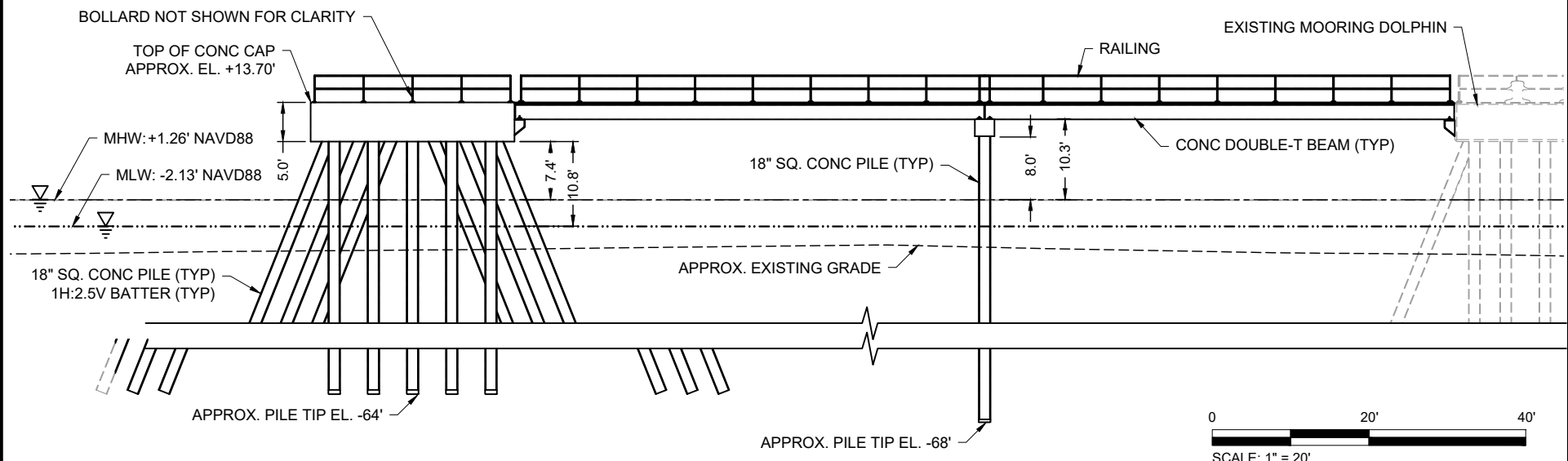
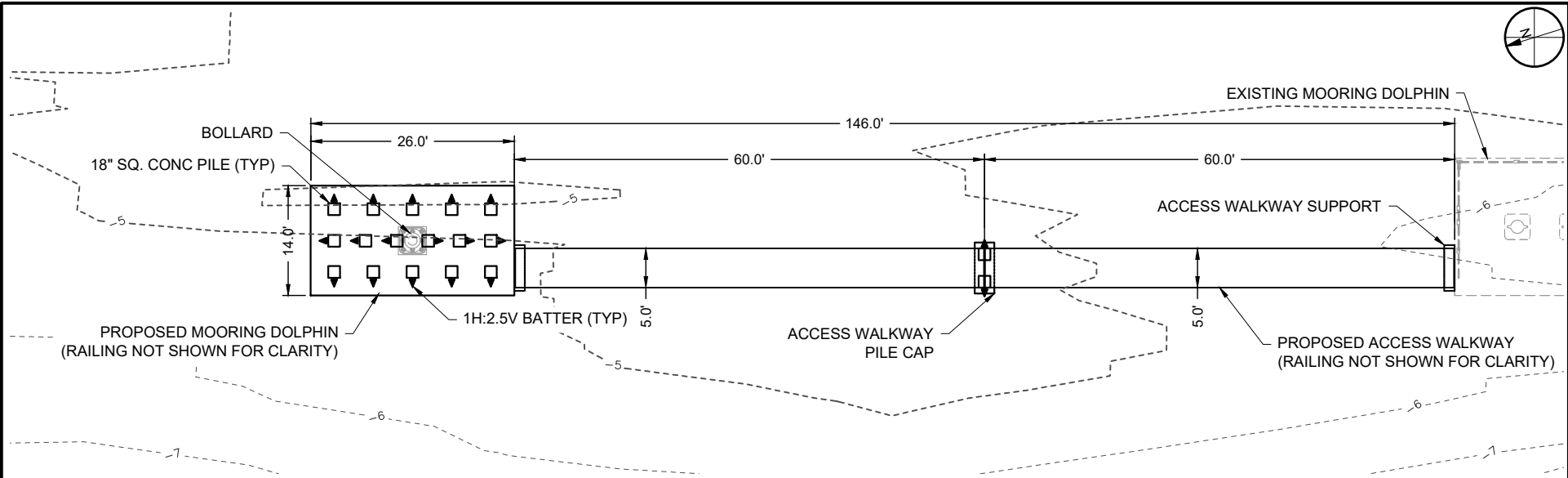

ELEVATIONS IN FT, NAVD88

ANTON FLEWELING X:\S\PROJECTS\C2021-051-P-SITE PLANS.DWG 3/4/2022 3:49:24 PM

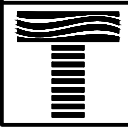

TAYLOR ENGINEERING INC.
 10199 SOUTHSIDE BLVD SUITE 310
 JACKSONVILLE, FLORIDA 32256
 REGISTRY # 4815

FIGURE 5
 MOORING DOLPHIN PLAN AND ELEVATION
 BLOUNT ISLAND MARINE TERMINAL -- BERTH 22 PIER EXPANSION AND NEW DOLPHINS
 DUVAL COUNTY, FLORIDA

PROJECT	C2021-051
DRAWN BY	AF
SHEET	5 of 9
DATE	MAR 2022

PRELIMINARY DRAWINGS: THESE DRAWINGS ARE NOT IN FINAL FORM, BUT ARE BEING TRANSMITTED FOR AGENCY REVIEW.

ANTON FLEWELLING X:\S\PROJECTS\C2021-051_BERTH22\PERMIT\FEDERAL\C2021-051-P-SITE PLANS.DWG 3/4/2022 3:50:36 PM

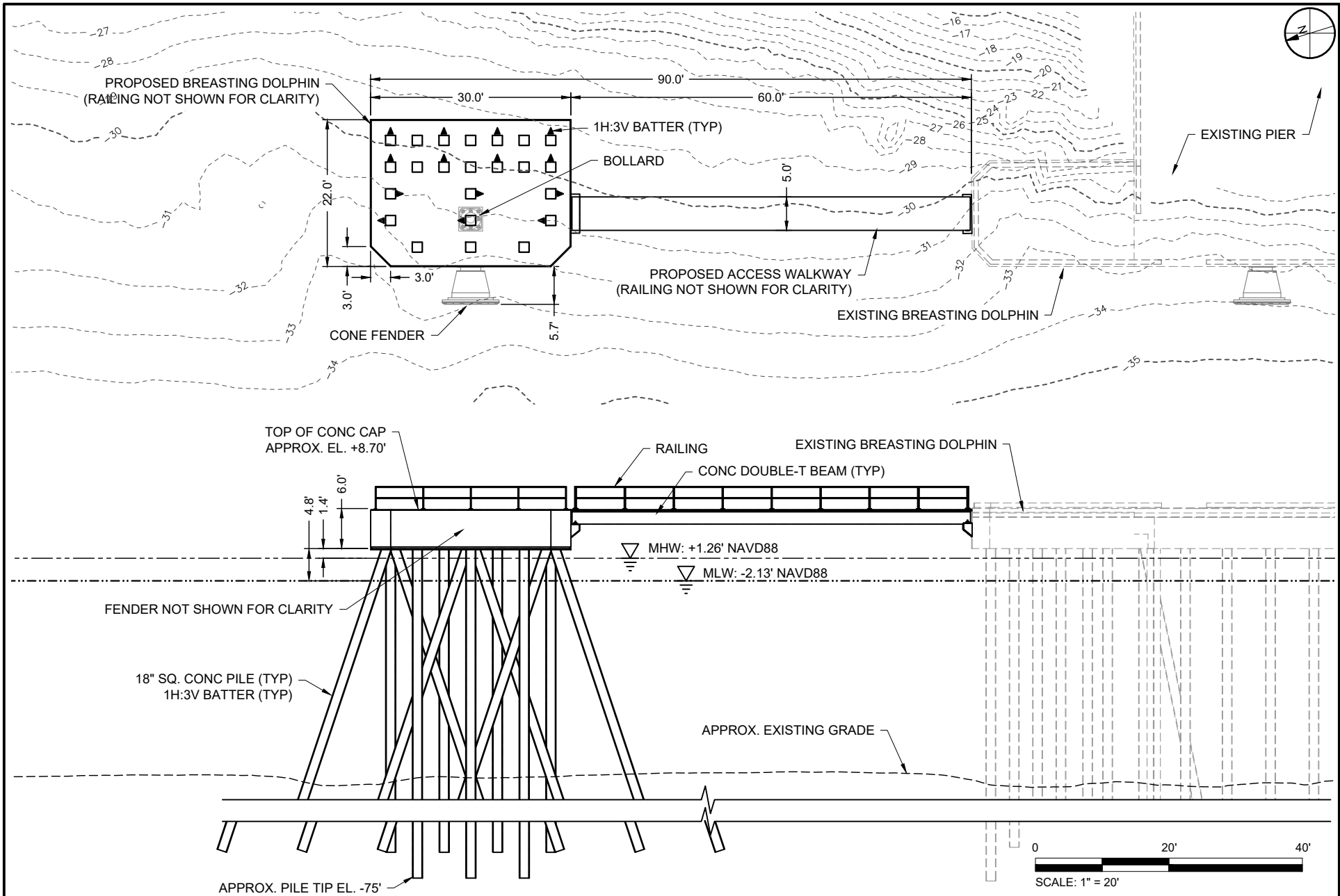

ELEVATIONS IN FT, NAVD88

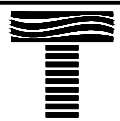

TAYLOR ENGINEERING INC.

10199 SOUTHSIDE BLVD SUITE 310
JACKSONVILLE, FLORIDA 32256
REGISTRY # 4815

FIGURE 6
BREASTING DOLPHIN PLAN AND ELEVATION
BLOUNT ISLAND MARINE TERMINAL -- BERTH 22 PIER EXPANSION AND NEW DOLPHINS
DUVAL COUNTY, FLORIDA

PROJECT	C2021-051
DRAWN BY	AF
SHEET	6 of 9
DATE	MAR 2022

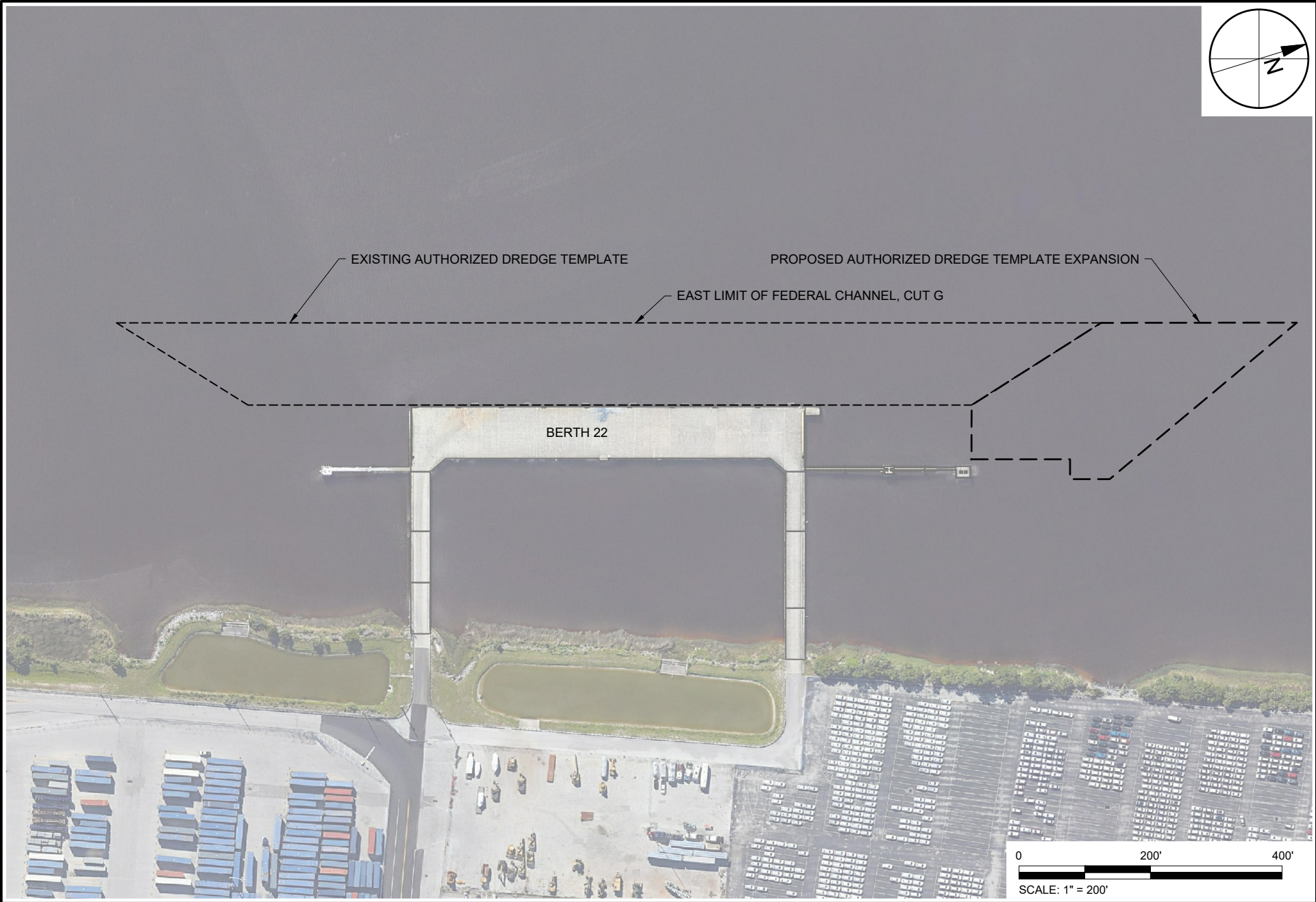
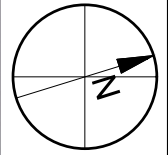

ANTON FLEWELLING X:\SIP\PROJECTS\C2021-051_BERTH22\PERMIT\FEDERAL\C2021-051-P-SSL EXISTING DWG 3/4/2022 3:51:03 PM

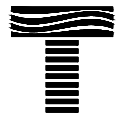

TAYLOR ENGINEERING INC.

10199 SOUTHSIDE BLVD SUITE 310
 JACKSONVILLE, FLORIDA 32256
 REGISTRY # 4815

FIGURE 7
 AUTHORIZED DREDGING TEMPLATE OVERVIEW
 BLOUNT ISLAND MARINE TERMINAL -- BERTH 22 PIER EXPANSION AND NEW DOLPHINS
 DUVAL COUNTY, FLORIDA

PROJECT	C2021-051
DRAWN BY	AF
SHEET	7 of 9
DATE	MAR 2022

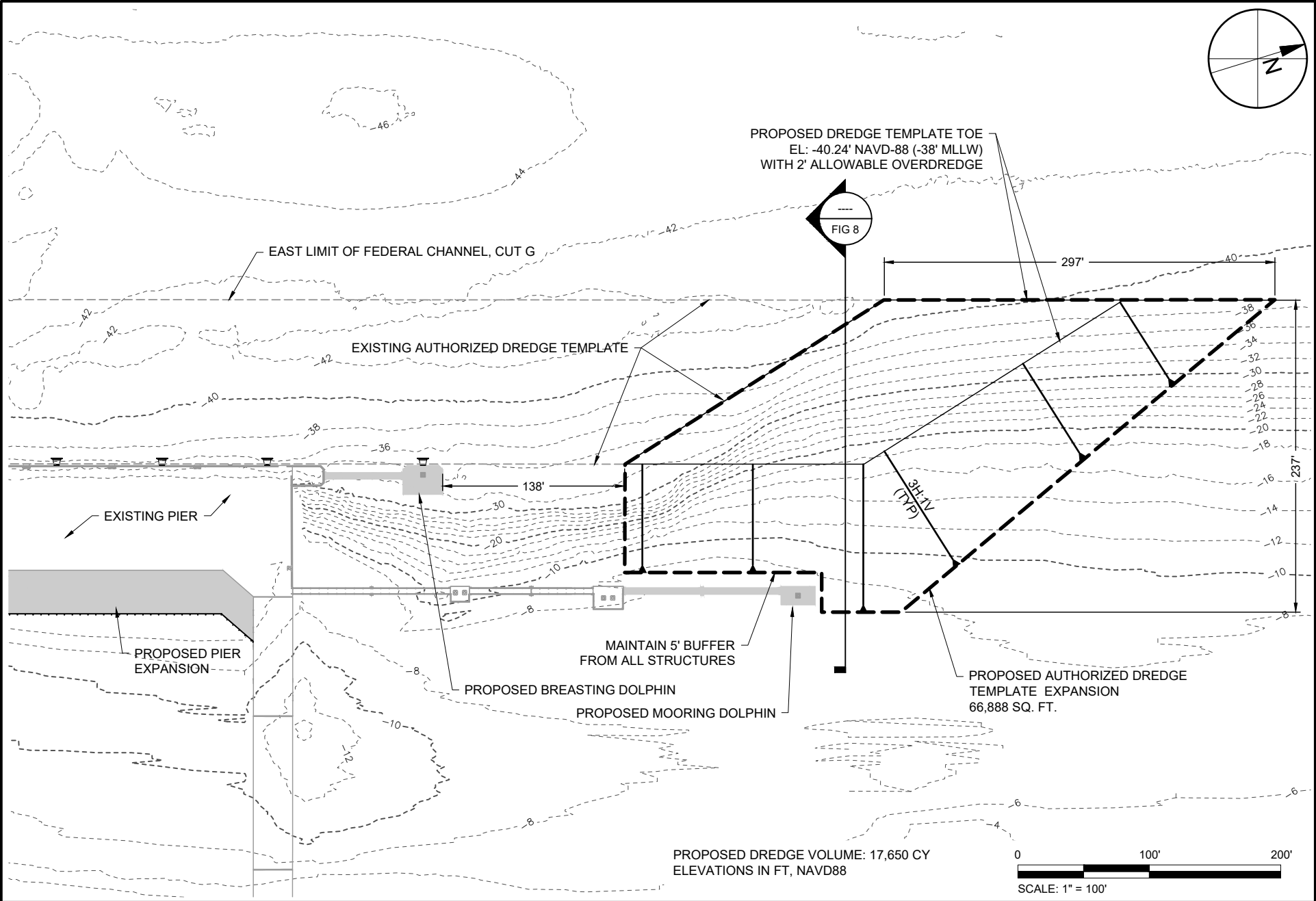
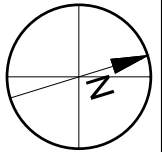

ANTON FLEWELING X:\S\PROJECTS\C2021-051_P-DREDGE PLAN.DWG 3/4/2022 3:51:33 PM



TAYLOR ENGINEERING INC.
 10199 SOUTHSIDE BLVD SUITE 310
 JACKSONVILLE, FLORIDA 32256
 REGISTRY # 4815

FIGURE 8
DREDGING PLAN
 BLOUNT ISLAND MARINE TERMINAL -- BERTH 22 PIER EXPANSION AND NEW DOLPHINS
 DUVAL COUNTY, FLORIDA

PROJECT	C2021-051
DRAWN BY	AF
SHEET	8 of 9
DATE	MAR 2022

PRELIMINARY DRAWINGS: THESE DRAWINGS ARE NOT IN FINAL FORM, BUT ARE BEING TRANSMITTED FOR AGENCY REVIEW.

ANTON FLEWELING X:\S\PROJECTS\C2021-051-P-TYPICAL SECTION.DWG 3/4/2022 3:51:45 PM

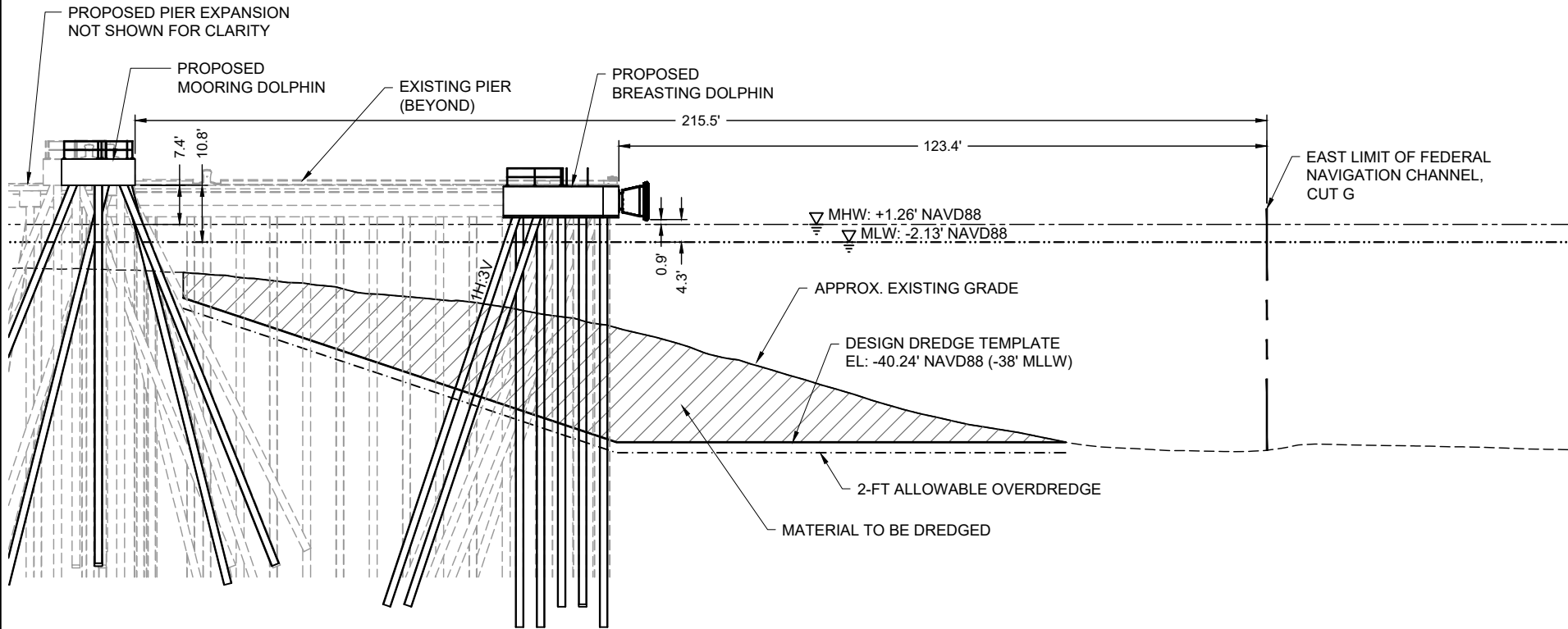

ELEVATIONS IN FT, NAVD88

0 30' 60'



SCALE: 1" = 30'

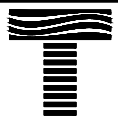

TAYLOR ENGINEERING INC.

10199 SOUTHSIDE BLVD SUITE 310
JACKSONVILLE, FLORIDA 32256
REGISTRY # 4815

FIGURE 9
TYPICAL CROSS-SECTION
BLOUNT ISLAND MARINE TERMINAL -- BERTH 22 PIER EXPANSION AND NEW DOLPHINS
DUVAL COUNTY, FLORIDA

PROJECT	C2021-051
DRAWN BY	AF
SHEET	9 of 9
DATE	MAR 2022

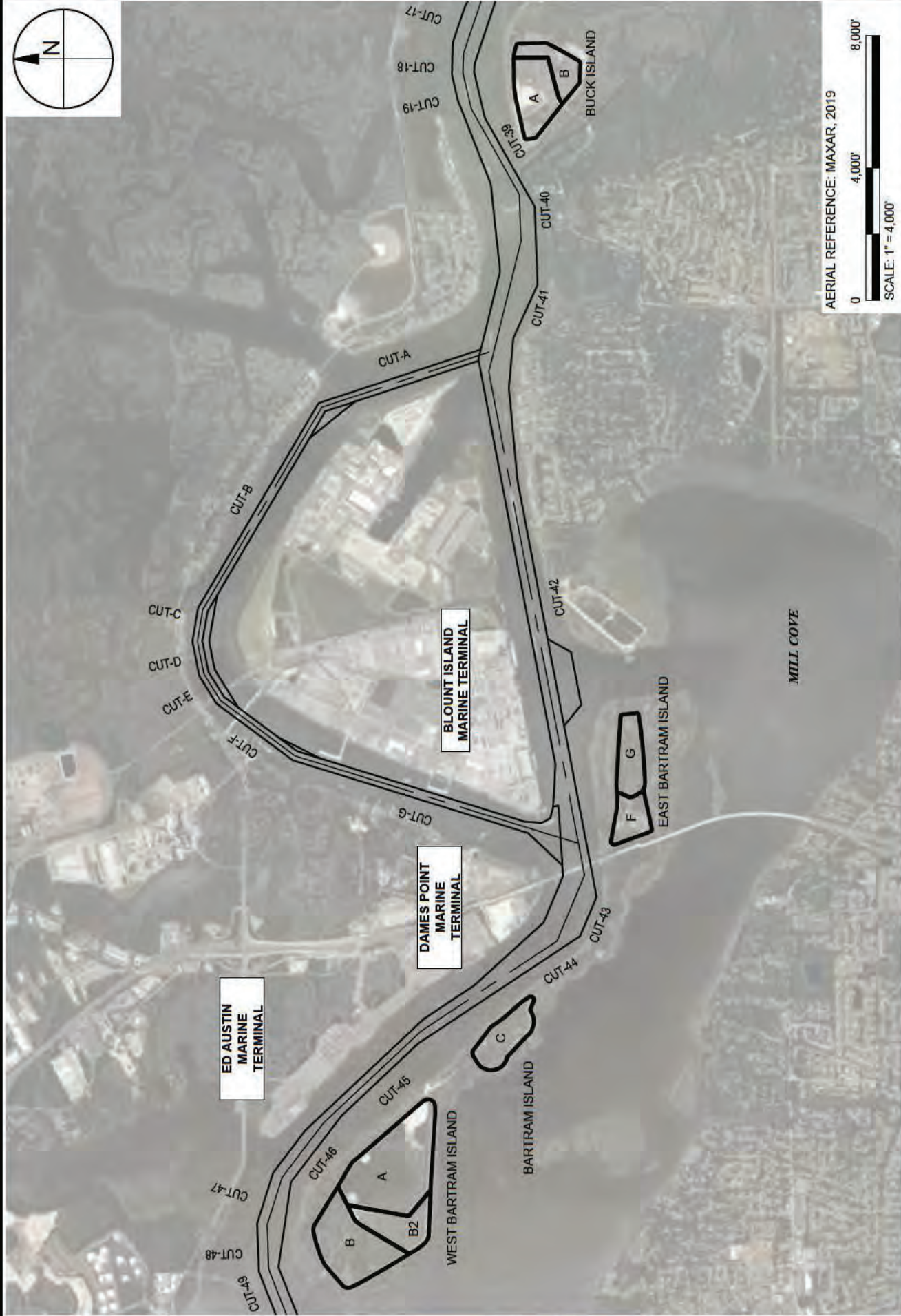

PROJECT	C2021-020
DRAWN BY	CAS
SHEET	3 of 22
DATE	AUG 2021

FIGURE 3
 UPLAND DREDGED MATERIAL DISPOSAL AREAS
 MAINTENANCE DREDGING PERMIT REAUTHORIZATION
 JACKSONVILLE PORT AUTHORITY (JAXPORT)
 DUVAL COUNTY, FLORIDA

TAYLOR ENGINEERING INC.
 10199 SOUTHSIDE BLVD. SUITE 310
 JACKSONVILLE, FLORIDA 32256
 REGISTRY # 4815

PRELIMINARY DRAWINGS: THESE DRAWINGS ARE NOT IN FINAL FORM, BUT ARE BEING TRANSMITTED FOR AGENCY REVIEW.

STANDARD MANATEE CONDITIONS FOR IN-WATER WORK

2011

The permittee shall comply with the following conditions intended to protect manatees from direct project effects:

- a. All personnel associated with the project shall be instructed about the presence of manatees and manatee speed zones, and the need to avoid collisions with and injury to manatees. The permittee shall advise all construction personnel that there are civil and criminal penalties for harming, harassing, or killing manatees which are protected under the Marine Mammal Protection Act, the Endangered Species Act, and the Florida Manatee Sanctuary Act.
- b. All vessels associated with the construction project shall operate at "Idle Speed/No Wake" at all times while in the immediate area and while in water where the draft of the vessel provides less than a four-foot clearance from the bottom. All vessels will follow routes of deep water whenever possible.
- c. Siltation or turbidity barriers shall be made of material in which manatees cannot become entangled, shall be properly secured, and shall be regularly monitored to avoid manatee entanglement or entrapment. Barriers must not impede manatee movement.
- d. All on-site project personnel are responsible for observing water-related activities for the presence of manatee(s). All in-water operations, including vessels, must be shutdown if a manatee(s) comes within 50 feet of the operation. Activities will not resume until the manatee(s) has moved beyond the 50-foot radius of the project operation, or until 30 minutes elapses if the manatee(s) has not reappeared within 50 feet of the operation. Animals must not be herded away or harassed into leaving.
- e. Any collision with or injury to a manatee shall be reported immediately to the Florida Fish and Wildlife Conservation Commission (FWC) Hotline at 1-888-404-3922. Collision and/or injury should also be reported to the U.S. Fish and Wildlife Service in Jacksonville (1-904-731-3336) for north Florida or Vero Beach (1-772-562-3909) for south Florida, and to FWC at ImperiledSpecies@myFWC.com
- f. Temporary signs concerning manatees shall be posted prior to and during all in-water project activities. All signs are to be removed by the permittee upon completion of the project. Temporary signs that have already been approved for this use by the FWC must be used. One sign which reads *Caution: Boaters* must be posted. A second sign measuring at least 8 ½" by 11" explaining the requirements for "Idle Speed/No Wake" and the shut down of in-water operations must be posted in a location prominently visible to all personnel engaged in water-related activities. These signs can be viewed at MyFWC.com/manatee. Questions concerning these signs can be sent to the email address listed above.

CAUTION: MANATEE HABITAT

All project vessels

IDLE SPEED / NO WAKE

When a manatee is within 50 feet of work
all in-water activities must

SHUT DOWN

Report any collision with or injury to a manatee:

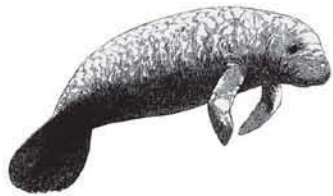

Wildlife Alert:

1-888-404-FWCC(3922)

cell *FWC or #FWC



PROTECTED SPECIES CONSTRUCTION CONDITIONS, NOAA FISHERIES SOUTHWEST REGIONAL OFFICE

The action agency and any permittee shall comply with the following construction conditions for protected species under the jurisdiction of NOAA Fisheries Southwest Regional Office (SERO) Protected Resources Division (PRD):¹

Protected Species Sightings—The action agency and any permittee shall ensure that all personnel associated with the project are instructed about the potential presence of species protected under the Endangered Species Act (ESA) and the Marine Mammal Protection Act (MMPA). All on-site project personnel are responsible for observing water-related activities for the presence of protected species. All personnel shall be advised that there are civil and criminal penalties for harming, harassing, or killing listed species and all marine mammals. To determine which protected species and critical habitat may be found in the transit area, please review the relevant [marine mammal](https://www.fisheries.noaa.gov/find-species) and [ESA-listed species](https://www.fisheries.noaa.gov/find-species) at Find A Species (<https://www.fisheries.noaa.gov/find-species>) and the consultation documents that have been completed for the project.

1. **Equipment**—Turbidity curtains, if used, shall be made of material in which protected species cannot become entangled and be regularly monitored to avoid protected species entrapment. All turbidity curtains and other in-water equipment shall be properly secured with materials that reduce the risk of protected species entanglement and entrapment.
 - a. In-water lines (rope, chain, and cable, including the lines to secure turbidity curtains) shall be stiff, taut, and non-looping. Examples of such lines are heavy metal chains or heavy cables that do not readily loop and tangle. Flexible in-water lines, such as nylon rope or any lines that could loop or tangle, shall be enclosed in a plastic or rubber sleeve/tube to add rigidity and prevent the line from looping and tangling. In all instances, no excess line shall be allowed in the water. All anchoring shall be in areas free from hardbottom and seagrass.
 - b. Turbidity curtains and other in-water equipment shall be placed in a manner that does not entrap protected species within the project area and minimizes the extent and duration of their exclusion from the project area.
 - c. Turbidity barriers shall be positioned in a way that minimizes the extent and duration of protected species exclusion from important habitat (e.g. critical habitat, hardbottom, seagrass) in the project area.
2. **Operations**—For construction work that is generally stationary (e.g., barge-mounted equipment dredging a berth or section of river, or shore-based equipment extending into the water):
 - a. Operations of moving equipment shall cease if a protected species is observed within 150 feet of operations.

¹ Manatees are managed under the jurisdiction of the U.S. Fish and Wildlife Service.

- b. Activities shall not resume until the protected species has departed the project area of its own volition (e.g., species was observed departing or 20 minutes have passed since the animal was last seen in the area).
3. **Vessels**—For projects requiring vessels, the action agency, and any permittee shall ensure conditions in the [Vessel Strike Avoidance Measures](#) are implemented as part of the project/permit issuance (<https://www.fisheries.noaa.gov/southeast/consultations/regulations-policies-and-guidance>).
4. **Consultation Reporting Requirements**—Any interaction with a protected species shall be reported immediately to NOAA Fisheries SERO PRD and the local authorized stranding/rescue organization.

To report to NOAA Fisheries SERO PRD, send an email to takereport.nmfsser@noaa.gov. Please include the species involved, the circumstances of the interaction, the fate and disposition of the species involved, photos (if available), and contact information for the person who can provide additional details if requested. Please include the project's Environmental Consultation Organizer (ECO) number and project title in the subject line of email reports.

To report the interaction to the local stranding/rescue organization, please see the following website for the most up to date information for reporting sick, injured, or dead protected species:

Reporting Violations—To report an ESA or MMPA violation, call the NOAA Fisheries Enforcement Hotline. This hotline is available 24 hours a day, 7 days week for anyone in the United States.

NOAA Fisheries Enforcement Hotline (800) 853-1964

5. **Additional Conditions**—Any special construction conditions, required of your specific project, outside these general conditions, if applicable, will be addressed in the project consultation and must also be complied with.

For additional information, please contact NOAA Fisheries SERO PRD at:

NOAA Fisheries Service
Southeast Regional Office
263 13th Avenue South
St. Petersburg, Florida 33701
Tel: (727) 824-5312

Visit us on the web at [Protected Marine Life in the Southeast](#)
(<https://www.fisheries.noaa.gov/region/southeast#protected-marine-life>)

Revised: May 2021

APPENDIX K

Standard Terms and Conditions

This appendix includes the standard conditions that must be included in all Section 408 approval notifications, except where marked as optional. Use of optional conditions should be based on scope and scale of the approved activity:

LIMITS OF THE AUTHORIZATION

1. This permission only authorizes you, the requester, to undertake the activity described herein under the authority provided in Section 14 of the Rivers and Harbors Act of 1899, as amended (33 USC 408). This permission does not obviate the need to obtain other federal, state, or local authorizations required by law. This permission does not grant any property rights or exclusive privileges, and you must have appropriate real estate instruments in place prior to construction and/or installation.
2. The time limit for completing the work authorized ends on _____. If you find that you need more time to complete the authorized activity, submit your request for a time extension to this office for consideration at least one month before the above date is reached. **Addressed in the 408 approval letter or 408 EN Memo.**
3. Without prior written approval of the USACE, you must neither transfer nor assign this permission nor sublet the premises or any part thereof, nor grant any interest, privilege or license whatsoever in connection with this permission. Failure to comply with this condition will constitute noncompliance for which the permission may be revoked immediately by USACE.
4. The requester understands and agrees that, if future operations by the United States require the removal, relocation, or other alteration of the work herein authorized, or if, in the opinion of the Secretary of the Army or an authorized representative, said work will cause unreasonable conditions and/or obstruction of USACE project authorized design, the requester will be required upon due notice from the USACE, to remove, relocate, or alter the structural work or obstructions caused thereby, without expense to the United States. No claim can be made against the United States on account of any such removal or alteration.

INDEMNIFICATION AND HOLD HARMLESS

5. The United States will in no case be liable for:
 - a. any damage or injury to the structures or work authorized by this permission that may be caused or result from future operations undertaken by the United States, and no claim or right to compensation will accrue from any damage; or
 - b. damage claims associated with any future modification, suspension or revocation of this permission.

10 Sep 18

6. The United States will not be responsible for damages or injuries which may arise from or be incident to the construction, maintenance, and use of the project requested by you, nor for damages to the property or injuries to your officers, agents, servants, or employees, or others who may be on your premises or project work areas or the federal project(s) rights-of-way. By accepting this permission, you hereby agree to fully defend, **indemnify**, and **hold harmless** the United States and USACE from any and all such claims, subject to any limitations in law.
7. Any damage to the water resources development project or other portions of any federal project(s) resulting from your activities must be repaired at your expense.

REEVALUATION OF PERMISSION

8. The determination that the activity authorized by this permission would not impair the usefulness of the federal project and would not be injurious to the public interest was made in reliance on the information you provided.
9. This office, at its sole discretion, may reevaluate its decision to issue this permission at any time circumstances warrant, which may result in a determination that it is appropriate or necessary to modify or revoke this permission. Circumstances that could require a reevaluation include, but are not limited to, the following:
 - a. you fail to comply with the terms and conditions of this permission;
 - b. the information provided in support of your application for permission proves to have been inaccurate or incomplete; or
 - c. significant new information surfaces which this office did not consider in reaching the original decision that the activity would not impair the usefulness of the water resources development project and would not be injurious to the public interest.

CONDUCT OF WORK UNDER THIS PERMISSION

10. You are responsible for implementing any requirements for mitigation, reasonable and prudent alternatives, or other conditions or requirements imposed as a result of environmental compliance.
11. Work/usage allowed under this permission must proceed in a manner that avoids interference with the inspection, operation, and maintenance of the federal project.
12. In the event of any deficiency in the design or construction of the requested activity, you are solely responsible for taking remedial action to correct the deficiency.
13. The right is reserved to the USACE to enter upon the premises at any time and for any purpose necessary or convenient in connection with government purposes, to make inspections, to operate and/or to make any other use of the lands as may be necessary in connection with government purposes, and you will have no claim for damages on account thereof against the United States or any officer, agent or employee thereof.

10 Sep 18

14. You must provide copies of pertinent design, construction, and/or usage submittals/documents. USACE may request that survey and photographic documentation of the alteration work and the impacted project area be provided before, during, and after construction and/or installation.
15. You may be required to perform an inspection of the federal project with the USACE, prior to your use of the structure, to document existing conditions.
16. USACE shall not be responsible for the technical sufficiency of the alteration design nor for the construction and/or installation work.
17. (optional, at the discretion of the district) Once permission is granted, you must notify the USACE District at least () days before work/usage is started so that post- permission oversight can be performed by USACE.
18. (optional, at the discretion of the district) You must schedule a final inspection with the USACE within () days after completion of the work/usage.
19. (optional, at the discretion of the district) You must submit a copy of "as-built" drawings within () days of completion of work showing the new work as it relates to identifiable features of the federal project. **Included in the 408 approval letter.**

MEMORANDUM FOR Chief, Regulatory Division

SUBJECT: JaxPort Berth 22 Expansion, Blount Island Channel, Duval County, Florida
Regulatory File #SAJ-1994-03114.

1. Reference Regulatory email dated 6 July 2022, requesting Engineering Division review the permit package for SAJ-2021-00197 JaxPort Berth 22 Expansion (2022-0073). The applicant seeks authorization to modify and expand an existing berth to accommodate larger vessels. The proposal includes the 8,896-square-foot landward expansion of a section of an existing pier adding an additional 954-square-foot breasting dolphin, adding an additional 970-square-foot mooring dolphin with catwalk to the existing dolphin, and performing necessary repairs to the underdeck concrete spall, piles (jacket installation), bollards, and fenders of the existing structure. The applicant will also expand the dredge template by 66,888 square feet to include removing an additional 17,650 cubic yards of the sediments to a depth of 38 feet below the mean low water line (with 2 feet of allowable overdredge). The dredge material will be disposed of at an approved JaxPort Upland Disposal Facility.
2. Engineering Division does not object to issuance of the permit and approves the request for SAJ-1994-03114 JaxPort Berth 22 Expansion (2022-0073) as referenced herein as the proposed meets SAJ criteria and will not impact the federal project.
3. Approval of these modifications to Blount Island Channel Project is in accordance with 33 U.S.C. 408. It also complies with the National Environmental Policy Act, as the proposed modifications were previously analyzed in the Department of Army Permits SAJ-1994-03114.
4. The applicant shall comply with Engineering Circular 1165-2-220, dated 10 September 2018, Policy and Procedural Guidance for Processing Requests to Alter U.S. Army Corps of Engineers Civil Works Projects Pursuant to 33 U.S.C. 408, Appendix K, paragraphs 1. to 16. (enclosed) and the time limit for completing the work authorized in Department of Army Permits SAJ-1994-03114. The applicant is responsible for quality control for performance of the work and for ensuring these actions do not interfere with the functioning of the Blount Island Channel Project. Documentation of the completed work must be furnished to USACE within 60 days after completion of the work for our records. This documentation will need to include a certification that the work was completed in accordance with the approved plans and specifications, GPS readings for the limits of the work performed, as-built drawings, and the date the work started and was completed.
5. If you have any questions, please feel free to contact the Engineering Division POC Murika Davis at 904-232-1604 or by email to murika.davis@usace.army.mil.

Lauren A. Boročaner, P.E.
Chief, Engineering Division

AS-BUILT CERTIFICATION BY PROFESSIONAL ENGINEER

Submit this form and one set of as-built engineering drawings to the U.S. Army Corps of Engineers, Enforcement Section, P.O. Box 4970, Jacksonville, Florida, 32262. If you have questions regarding this requirement, please contact the Enforcement Branch at 904-232-3131.

1. Department of the Army Permit Number: SAJ-1994-03114 (SP-BJC)

2. Permittee Information:

Name: _____

Address: _____

3. Project Site Identification (physical location/address):

4. As-Built Certification: I hereby certify that the authorized work, including any mitigation required by Special Conditions to the permit, has been accomplished in accordance with the Department of the Army permit with any deviations noted below. This determination is based upon on-site observation, scheduled, and conducted by me or by a project representative under my direct supervision. I have enclosed one set of as-built engineering drawings.

Signature of Engineer

Name (*Please type*)

(FL, PR, or VI) Reg. Number

Company Name

City

State

ZIP

(Affix Seal)

Date

Telephone Number

COMMENCEMENT NOTIFICATION

Within ten (10) days of initiating the authorized work, submit this form via electronic mail to saj-rd-enforcement@usace.army.mil (preferred, not to exceed 15 MB) or by standard mail to U.S. Army Corps of Engineers, Enforcement Section, Post Office Box 4970, Jacksonville, Florida 32232-0019.

1. Department of the Army Permit Number: SAJ-1994-03114

2. Permittee Information:

Name: _____

Email: _____

Address: _____

Phone: _____

3. Construction Start Date: _____

4. Contact to Schedule Inspection:

Name: _____

Email: _____

Phone: _____

Signature of Permittee

Printed Name of Permittee

Date

THIS PAGE INTENTIONALLY LEFT BLANK